

# **QUICK203G**

**High-Power Intelligent Lead Free Soldering Station**

**High Frequency Heating      Rapid Recovery of Temperature**

## **Operation and Maintenance Manual**

Thank you for purchasing a Intelligent Lead Free Soldering Station. It is designed for lead free soldering. Please read this manual before operating the unit. Store this manual in a safe, easily accessible place for future reference.

# Table of Contents

Precautions.....	
Name of Parts.....	
Setting up & Operating station.....	
Parameters.....	
Sleeping.....	
Select the correct tip for a soldering station.....	
Calibrating the iron temperature.....	
Tip care and use.....	
Maintenance.....	
Error Messages.....	
Trouble shooting Guide.....	
Checking for breakage of the heating element and cord assembly.....	
Replace the fuse.....	
Specification.....	
Tips.....	

# Precautions

In this instruction manual, “Warning”, “Caution” and “Note” are defined as follows.

## WARNING

 WARNING: Misuse may potentially cause death of, or serious injury to the user.

 CAUTION: Misuse may potentially cause injury to the user or physical damage to the objects involved.

For your own safety, be sure to comply with these precautions.

NOTE: A NOTE indicates a procedure or point that is important to the process being described.

---

## CAUTION

When the power is on, the tip temperature is very high. Since mishandling may lead to burns or fire, be sure to comply with the following precautions.

- Please avoid an abuse of the equipment, use the appliance only in the described way.
- Don't touch the metallic parts near the Tip.
- Don't use the product near flammable items.
- Advise other people in the work area that the unit can reach a very high temperature and should be considered potentially dangerous.
- Turn the power off while taking breaks and when finished using the unit.
- Before replacing parts or storing the unit, turn the power off and allow the unit to cool to room temperature.

To prevent damage to the unit and ensure a safe working environment, be sure to comply with the following precautions.

- Appliance shall only be used with rated voltage and frequency. (Refer to the trademark back of equipment.)
- Don't use or stop the use if the appliance is damaged, especially the supply cord.
- This machine is equipped with a 3-wires grounding plug and must be plugged into a 3-terminal grounded socket. Do not modify plug or use an ungrounded power socket. If an extension cord is necessary, use only a 3-wire extension cord that provides grounding.
- Do not use the unit for applications other than soldering.
- Do not rap the soldering iron against the work bench to shake off residual solder, or otherwise subject the iron to severe shocks.
- Do not modify the unit.
- Use only genuine replacement parts.

- Do not wet the unit or use and disconnect the unit when your hands are wet and without to force the supply cord.
- The soldering process will produce smoke, so make sure the area is well ventilated.
- While using the unit, don't do anything which may cause bodily harm or physical damage.
- Children don't recognize the risks of electrical appliances. Therefore use or keep the appliance only under supervision of adults and out of the reach from children.

## Names of Parts

---

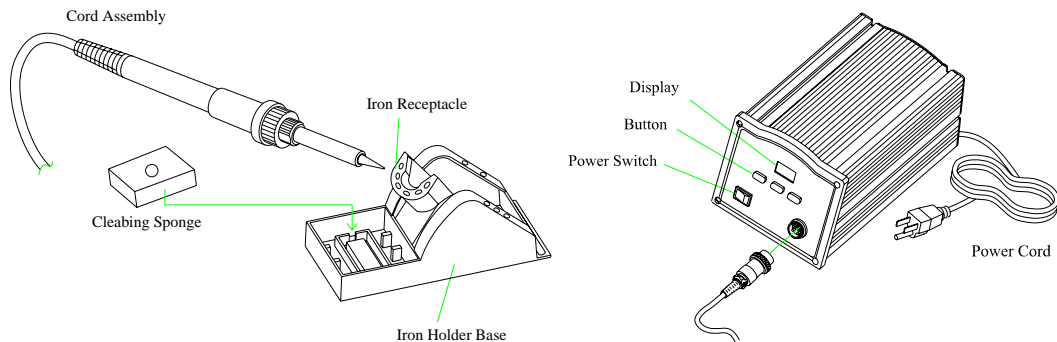

## Setting up & Operating the soldering station

---



**CAUTION:** The sponge is compressed. It will swell when moistened with water.

Before using the unit, dampen the sponge with the water and squeeze it dry. Failure to do so may result in damage to the Soldering tip.

### Iron Holder

#### 1. Small Cleaning Sponge

Dampen the small cleaning sponge with water and then squeeze it dry.

Place it in one of the openings of the iron holder base.

2. Add water to the approximate level as shown. The small sponge will absorb water to keep the large sponge above it wet at all times.

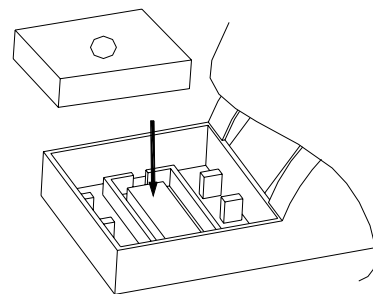

\*The large sponge may be used alone (without small sponge & water).

3. Dampen the large cleaning sponge and place it on the iron holder base.

## Connections

 **CAUTION:** Be sure to turn off the power switch before connecting or disconnecting the soldering iron. Failure to do so may result in damage to the soldering station.

1. Connect the cord assembly to the receptacle.
2. Place the soldering iron in the iron holder.
3. Plug the power cord into a power supply. Be sure to ground the unit.
4. Turn the power switch on.  
The temperature is preset at 300°C or 350 °C at the factory.  
The heater lamp flickers when the temperature has stabilized.
5. Press the \* button to display the preset temperature. It will be displayed for two seconds.

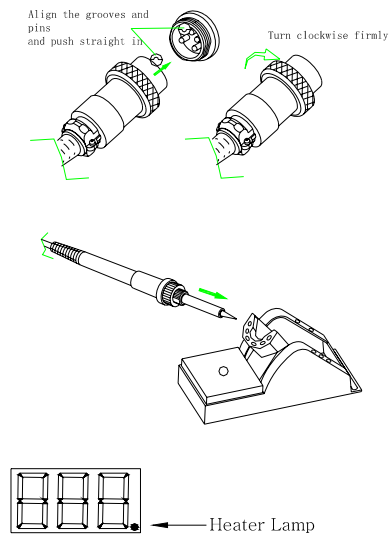

## Setting the temperature

Set Temperature Normally

 **CAUTION:** Make sure the temperature of the station can be adjusted (password is OK or the password is initial). While setting the temperature normally, the heating element is off.

If the “\*” button is pressed for less than one second, the present temperature setting will be shown for two seconds and then the display will return to showing the tip temperature.

**Example: 400°C to 350°C**

1.

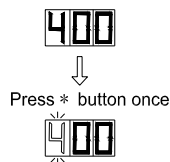

1. Press the \* button and hold it down for at least one second. The left-most digit (the 100's digit) in the display will flash. This indicates that the station is in temperature setting mode and that the 100's digit can be adjusted.
2. Select the desired value for 100's digit. Using the ▲ or ▼ button will change displayed

2.

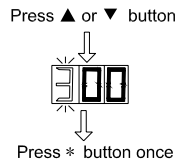

3.

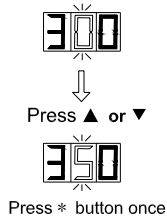

4.

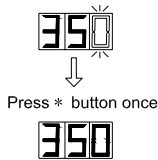

value as follows.



Press the \* button when the desired value is displayed. This will cause the middle digit (the 10's digit) in the display to begin flashing.

3. Select the desired value for the 10's digit. Using the ▲ or ▼ button will change displayed value as shown below.

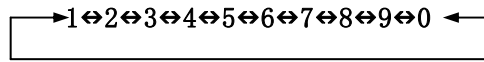

Press the \* button. The right (the 1's digit) will then begin flashing to indicate that the 1's digit can be set.

4. Select the desired value for the 1's digit. Using the ▲ or ▼ button will change the displayed value as shown above for the 10's digit selection. Press the \* button. Here, pressing the \* button.....

- A. enters the temperature setting into the internal memory.
- B. displays the temperature setting, and
- C. starts heater control

**Note:** If you turn off the power switch during the temperature setting, setting value will not be stored in the memory. If a temperature value outside of this range is selected, the display will return to flashing the 100's digit. If this happens, input a correct temperature value.

### Set temperature on-line

In the work, if it is necessary to set temperature quickly and the heat elements can't be cut off, the way may be selected.

Temperature rising:

Don't press \* button, and press ▲ button directly. If so, the setting temperature will raise one degree centigrade and the display window will display the set temperature. When loose the ▲ button, the display window will delay the set temperature about 2 seconds. If within 2 seconds of

time, press the ▲ button again, the setting temperature will raise one degree centigrade again. If press the ▲ button and not loose at least 1 second, the setting temperature will rise rapidly. Till the needed temperature reaches, then loose the ▲ button.

Temperature dropping:

Don't press \* button, and press ▼ button directly. If so, the setting temperature will drop one degree centigrade and the display window will display the set temperature. When loose the ▼ button, the display window will delay the set temperature about 2 seconds. If 2 seconds later, press the ▼ button again, the setting temperature will drop one degree centigrade again. If press the ▼ button and not loose at least 1 second, the setting temperature will drop rapidly. Till the needed temperature reaches, then loose the ▼ button.

## Parameters



---

The station has the following parameters. Parameters settings can be adjusted.

### Setting the password

The initial password in station's memory is 000. The setting temperature is admitted in this state. If need to restrict the setting temperature, the password must be changed.

#### Enter into Setting The Password

1. Turn off the power switch. Press and hold the ▲ and ▼ buttons simultaneously, then turn on the power switch.
2. Continue holding down the ▲ and ▼ buttons until the display shows  .
3. When the display shows  , the station is in parameter-input mode.
4. Press the \* button, the display shows  , and the left-most digit (100's digit) in the display will flash. This indicates the station is in password setting mode and the 100's digit can be adjusted. Using the ▲ or ▼ button will change displayed value. Set the password value in the same way described in "Set Temperature Normally". After selecting the password of three digit, press \* button.
5. If the display window shows the present setting temperature, two seconds later, the station is in normal work state. This indicates

#### Input Previously Password





#### The Password of input is error

**The Password of input is correct**

**Input New Password**



**Repeat the New Password**

the password of input is error, and the temperature setting can't be done.

6. If the display window shows  , this indicates the password of input is correct. After displaying about 4 seconds, the station comes into normal work state, and the setting temperature will be admitted.
7. When display window is showing  , press \* button, and shows  . It indicates the station comes into inputting new password state. Pressing ▲ or ▼ button will change displayed value. See “Set Temperature Normally”.
8. When three digits are selected, press \* button, the display window shows  again. Now must input the new password. Repeat the same steps.
9. If the password is the same as last time, the changed password is OK. The new password is stored into the internal memory.
10. If the password is not the same as last time, and the display window shows  , the station will need to rewrite new password. (see the last 8—9 steps). The changing of password is finished until the lately two passwords are identical.

Note: The word of password is 0 to 9, ten words. If not, the changed password is unsuccessful.

**Working Mode Setting**

If the display window shows  , press and hold the ▲ and ▼ buttons simultaneously, then the display shows  . This indicates the unit comes into working mode setting state, and



pressing ▲ or ▼ button will change displayed value as shown below:

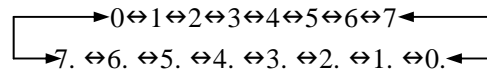

After selecting the working mode, press\* button down. The working mode is stored into the internal memory.

Please refer to the “Working Mode Table” for the meaning of the digit displayed.

Note: X represents the original working mode digit.

**⚠Warning:** The heater and soldering tips will be seriously oxidized or damaged when working with a high temperature. So please choose the working mode carefully and try to operate with a lower temperature if possible.

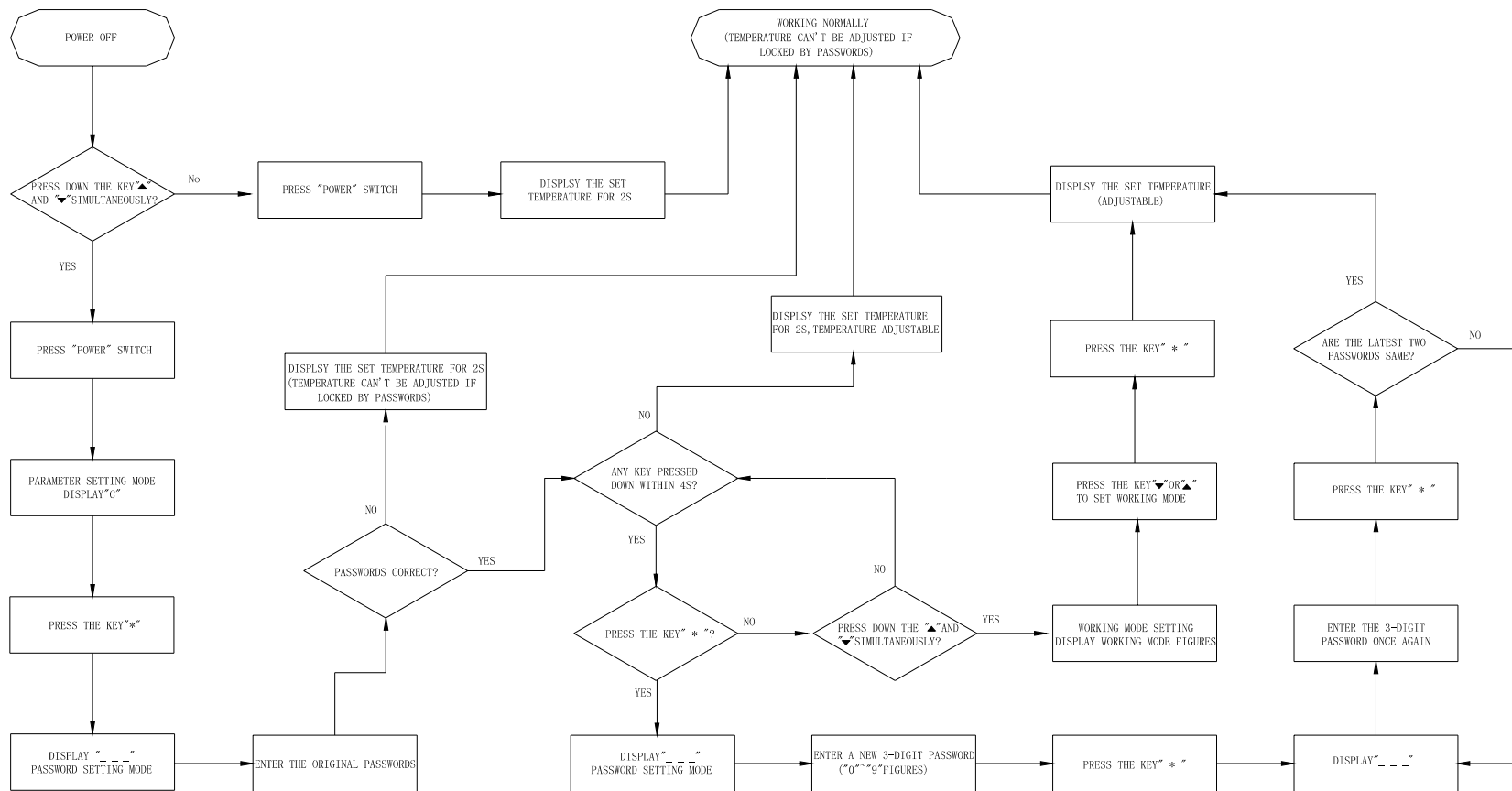

## WORKING MODES TABLE

WORKING MODE	HANDLE MODE	TEMPERATUE RANGE	AUTO SLEEPING AND SWITCHING OFF
0	High frequency soldering iron	200°C-420°C	Yes
1	High frequency soldering iron	200°C-420°C	Yes
2	High frequency tweezers or using special very large type of soldering tip	200°C-420°C	Yes
3	High frequency tweezers stripper iron	50°C-600°C	Yes
4	High frequency soldering iron	50°C-420°C	Yes
5	High frequency soldering iron	50°C-420°C	Yes
6	High frequency soldering iron	200°C-480°C	Yes
7	High frequency soldering iron	200°C-480°C	Yes
0.	High frequency soldering iron	200°C-420°C	No
1.	High frequency soldering iron	200°C-420°C	No
2.	High frequency tweezers or using special very large type of soldering tip	200°C-420°C	No
3.	High frequency tweezers stripper iron	50°C-600°C	No
4.	High frequency soldering iron	50°C-420°C	No
5.	High frequency soldering iron	50°C-420°C	No
6.	High frequency soldering iron	200°C-480°C	No
7.	High frequency soldering iron	200°C-480°C	No

**Note:** The station has many working modes and the default mode is six.

## Sleeping

If sleeping and working mode are selected, and the soldering iron is not used for 20 minutes, the power to the heating element will be decreased, and the display shows . This state is sleeping mode. When the station is in sleeping mode, the tip temperature will decrease to 200°C (if the set temperature is more than or equal to 200°C) or 50°C (if the set temperature is less than 200°C) and remain the temperature until resuming the station.

To resume soldering, there are several ways as follows:

1. Cycle the power switch OFF, then ON.
2. Hit any button.
3. Take up the iron-handpiece.

If the soldering station is not resumed more than 40 minutes after it comes to sleep, the power supply will be shut off automatically, and the display window will not show anything.

## To Select The Correct Tip For A Solder Application

---

1. Pick a tip that maximizes contact area between the tip and solder Joint. Maximizing contact area gives the most efficient heat transfer, allowing operators to produce high quality solder joints quickly.
2. Pick a tip that allows good access to the solder joint. Shorter tip lengths allow more precise control. Longer or angled may be needed for soldering densely populated boards.

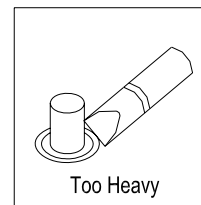
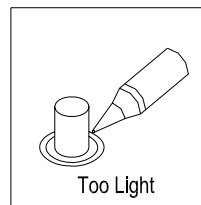
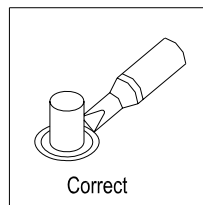

## Calibrating the Iron Temperature

---

The Soldering Iron should be recalibrated after changing the iron or replacing the heating element or tip.

**Method of recalibrating temperature: Use the thermometer to calibrate.**

1. Set the unit's temperature to a certain value.
2. When the temperature stabilizes, measure the tip's temperature with thermometer and write down the reading.
3. Press “\*” button not loose and press the “▲” and “▼” buttons simultaneously, the soldering station enters into calibration mode.
4. At the moment, the 100's digit of LED display temperature is flashing. Press the “▲” and “▼” buttons to select the value and press the “\*” button to select the digit. Press “\*” button after inputting the reading. Here, the calibration operation has finished.

5. If the temperature still has deflection, you can repeat calibration in accordance with above steps.
- \* We recommend using the 191/192 thermometer for measuring the tip temperature.
  - \* If the unit is locked by password, it will not be able to calibrate and you must input the right password.

## Tip Care and Use

---

### • Tip Temperature —————

High soldering temperatures can degrade the tip. Use the lowest possible soldering temperature. The excellent thermal recovery characteristics ensure efficient and effective soldering event at low temperatures. This also protects the soldered items from thermal damage.

### • Cleaning —————

Clean the tip regularly with a cleaning sponge, as oxides and carbides from the solder and flux can form impurities on the tip. These impurities can result in defective joints or reduce the tip's heat conductivity.

When using the soldering iron continuously, be sure to loosen the tip and remove all oxides at least once a week. This helps prevent seizure and reduction of the tip temperature.

### • When not in use —————

Never leave the soldering iron sitting at high temperature for long periods of time, as the tip's solder plating will become covered with oxide, which can greatly reduce the tip's heat conductivity.

### • After use —————

Wipe the tip and coat the tip with fresh solder. This helps to prevent tip oxidatio

## Maintenance

---

### Inspect and Clean the Tip

1. Set the temperature to 250°C.
2. When the temperature stabilizes, clean the tip with the cleaning sponge and check the condition of the tip.

 Caution: Never file the tip to remove oxide

### **Why A "Detinned" Tip fails To work?**

A detinned tip is one not wetted with solder. This exposes the plating to oxidation and degrades the heat transfer efficiency of the tip. Detinning is caused by :

### **To Restore A Detinned tip**

### **Extending Tip Life**

3. If there is black oxide on the solder-plated portion of the tip, apply new solder ( containing flux ) and wipe the tip on the cleaning sponge. Repeat until the oxide is completely remove. Coat with new solder. The solder protects the tip from oxidation and prolongs the life of the tip.
4. If the tip is deformed or heavily eroded, replace it with a new one.
  - a. Failure to keep the tip covered with fresh solder during idling periods.
  - b. High tip temperatures.
  - c. Lack of sufficient flux in soldering operations.
  - d. Wiping the tip on dirty or dry sponges and rags.( Always use a clean, wet, industrial grade, sulfur-free sponge.)
  - e. Impurities in the solder, iron plating ,or on the surfaces to be soldered

1. Remove the tip from the solder handle and allow the tip to cool down.
2. Remove scale and oxides from the tinned area of the tip with 80-grit abrasive polyurethane foam stock or a 100-grit emery cloth.
3. Wrap rosin core solder (0.031" diameter or larger) around the newly exposed iron surface, insert the tip into the handle, and turn on the system.

NOTE: Detinned tips are preventable with proper daily care!

1. Tin the tip before and after each use. This protects the tip from oxidizing, and prolongs the tip's life.
2. Do the job at the lowest temperature. Lower temperatures decrease tip oxidation and are easier on the components being joined.

3. Use fine point tips only when necessary. The plating on fine precision tips is less durable than the plating on blunter tips.
4. Do not use the tip as a prying tool. Bending the tip can cause the plating to crack, shortening tip life.
5. Use the minimum activation flux necessary to do the job. Higher activation flux is more corrosive to the tip plating.
6. Extend tip life by switching the system off when not in use.
7. Don't apply pressure to the tip. More pressure does not equal more heat. To improve heat transfer, use solder to form a thermal bridge between the tip and the solder joint.

## Error Messages

---

Various error messages will be display when there is a problem with the unit. If the following message is displayed, see the trouble shooting guide.

**S - E** Sensor Error

If there is a possibility of a failure in the sensor or anywhere in the sensor circuit, **S - E** will be displayed and power to the soldering iron will be cut off.

**Flash the Temperature Display**

Note

If power is being sent to soldering iron and the tip temperature goes below the setting temperature about 80°C, the temperature display will flash. Draw your attention to this.

**H - E** Heater Error

If power can't be sent to soldering iron, the display window will show **H - E**. This indicates the possibility of a heater malfunction.

# Trouble shooting Guide



## WARNING:

- Disconnect the power plug before servicing. Failure to do so may result in electric shock..
- If the power cord is damaged, it must be replaced by the manufacturer, its service agent or similarity qualified person in order to avoid personal injury or damage to the unit.

### Problem1.

The unit does not operate.

Check1. Is the fuse blown?

Determine why the fuse blew and eliminate the cause, then replace the fuse.

- a. Is the inside of the iron short-circuited?
- b. Is the grounding wire touching the heating element?
- c. Is the heating element lead twisted and short-circuited?

Check2. Is the power cord broken?

Replace it with a new one.

### Problem2.

The tip doesn't heat up.

Sensor Error **S - E** is displayed.

Check3. Is the power cord broken?

See how to check the breakage of cord assembly.

Check4. Is the sensor element broken?

See how to check the breakage of heating and sensor element.

### Problem3.

The tip heats up intermittently.

Check3

Check4

### Problem4.

Solder will not wet the tip.

Check5. Is the tip temperature too high?

Set an appropriate temperature

Check6. Is the tip cleaned?

See "Tip Care and Use".

### Problem5.

The temperature is too low.

Check7. Is the tip coated with oxide?

See "Inspect and clean the tip".

Check8. Is the iron calibrated correctly?

Please recalibrate.

### Problem6.

Heater error **H - E** is displayed.

Check9. Is the soldering Iron cord broken?

See how to check the breakage of cord assembly.

Check10. Is the heating element broken?

See how to check the breakage of heating and



	<p>sensor element.</p> <p>Check11. Is there a tip on the iron?</p> <p>Assemble a tip on the iron.</p>
<p>Problem7.</p> <p>Temperature value are displayed frequently.</p>	<p>Check12. Is the soldering iron cord broken?</p> <p>See how to check the breakage of heating and sensor element.</p> <p>Check13. Is the item to be soldered too big?</p> <p>Use a higher out power iron or ignore.</p>
<p>Problem8.</p> <p>Can't set the temperature.</p>	<p>Check14. Locked the button on the panel.</p> <p>Enter into setting the password.</p> <p>If you have forgot the password:</p> <p>Disassemble the Front panel (see parts list-station), plug the power into a power supply, turn the power switch on.</p> <p>Press the "D-S" button inside PCB (see parts list).</p> <p>The password will be resumed to "000". Assembly it in the reverse order of disassembly.</p>
<p>Problem9.</p> <p>Soldering iron heats up continually, with the indicator always lightening.</p>	<p>Check15. Is the sensor (with polarity) connected oppositely?</p> <p>Resolder the sensor wire.</p> <p>Check16. Is the sensor short-circuited?</p> <p>Replace the sensor.</p>

## Checking for Breakage of the Heating Element and Sensor Element

Disconnect the plug and measure the resistance value between the connecting plug pins as follows. If the value of 'a' and 'b' are outside the below value, replace the heating element (sensor) . Refer to procedures 1 and 2. If the value of 'c' is over the below value, remove the oxidization film by lightly rubbing with sand-paper or steel wool the points as shown.

a.	Between pins 4 &5 (Heating Element)	Under 4 Ω (Normal)
b.	Between pins 1 &2 (Sensor )	Under 10 Ω (Normal)
c.	Between pins 3 & Tip	Under 2 Ω

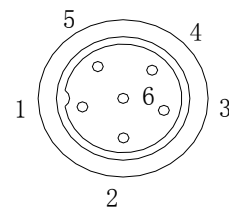

## Replacing the fuse

1. Unplug the power cord from the power receptacle.
2. Remove the broken fuse.
3. Remove the fuse holder.
4. Replace the fuse.
5. Put the fuse holder back in place.

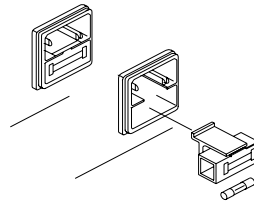

## Specification

---

Item	QUICK203G
Power Consumption	150W
Output Voltage/Frequency	36VAC, 400KHZ
Range of temperature	Decide by working mode
Tip to Ground Resistance	$<2\ \Omega$
Tip to Ground Potential	$<2\text{mV}$
Max Ambient Temperature	40°C
Temperature Stability	$\pm 2^\circ\text{C}$ / Without air flow and no load
Housing Material	Aluminum
Outer Dimension	200(L) × 130 (W) × 100(H) mm
Weight (Without cord)	3.7Kg
ESD Safe by design	

- The tip temperature is measured by 191 thermometer.
- Specification and design subject will be changed without notice.

# Tips

