

# **QUICK376D**

## **Self-Feeder Soldering Station**

### **Operation Manual**

Thank you for purchasing a Self-Feeder Lead Free Soldering Station. Please read this manual before operating the unit. Store this manual in a safe, easily accessible place for future reference.

# Tips

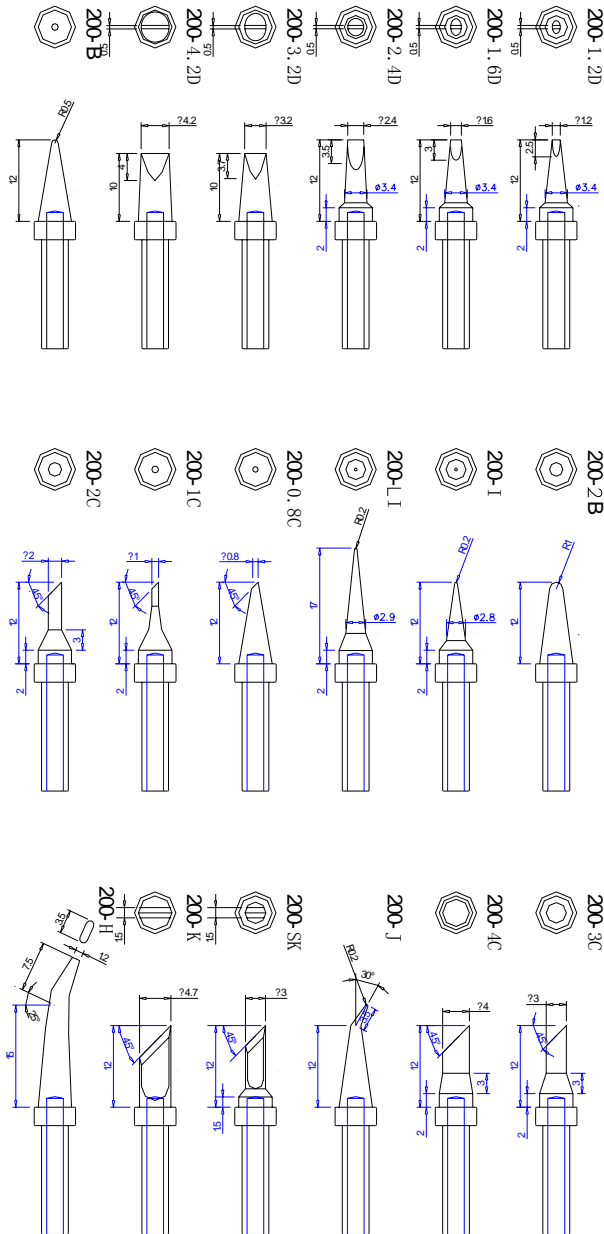

# CAUTION

- Appliance shall only be used with rated voltage and frequency. (Refer to the nameplate back of the unit)
- Don't use or stop the use if the appliance is damaged, especially the supply cord.
- Please avoid an abuse of the equipment, use the appliance only in the described manner.
- The appliance is used in the room.
- Before replacing tip or storing the unit, turn the power off and allow the tip to cool to room temperature due to the burned danger.
- Don't touch the metallic parts near the Tip.
- Don't use the unit for applications other than soldering.
- Don't rap the soldering iron against the work bench to shake off residual solder, or otherwise subject the iron to severe shocks.
- Don't wet the appliance and don't disconnect the appliance with wet hands and without to force the supply cord.
- The soldering process will produce smoke, so make sure the area is well ventilated.
- While using the unit, don't do anything that may cause bodily harm or physical damage.
- The unit is equipped with a 3-wires grounding plug and must be plugged into a 3-terminal grounded socket. Don't modify plug or use an ungrounded power socket.
- Children don't realize the risks of electrical appliance. Therefore use or keep the appliance only under supervision of adults and out of the reach from children.

## SECTION 1 Summary

The unit is Automatic self-feeder lead free soldering system. Digital display, adjusting with button, furthermore, design with automatic sleep and digital calibration function, easy and prompt to use. Adopt step motor, feeding precise and the precision is controlled optionally. Feeding speed and time, returning are all adjustable and steady, reach to perfect soldering effect and high efficiency. One hand operation, easy to solder. With the optimized combination, it works only with Soldering Iron without Soldering Station. The Soldering Iron adopts high frequency heating, rapid heat and recovery speed to realize lead free solder.

## SECTION 2 Specification

Working voltage of heating element	36V/400KHZ
Range of temperature	200℃~480℃
Temperature Stability	±2℃
Tip to Ground Potential	<2mv
Tip to Ground Resistance	<2 Ω
Max Power consumption of unit	90W
Motor	Step Motor
Feeding speed	About 2.7mm/s~27mm/s (36°/s~360°/s)
Feeding Length	0~150mm
Feeding Interval Time	0~2.7s
Returning Time	0~0.9s (About 0~25mm Speed: 360°/s)
Feeding Mode	Auto (1~9) / Manual (0)
Dia. of solder wire	0.5,0.6,0.8,1.0,1.2,1.4,1.6 (mm)
Weight of solder wire usable	≤1Kg (Roll)

15	Feeder Tube Assembly (0.8m) ø1.6mm	
16	Guide Tube Assembly ø0.6mm	Using on the top of Tip
17	Guide Tube Assembly ø0.8mm	Using on the top of Tip
18	Guide Tube Assembly ø1.0mm	Using on the top of Tip
19	Guide Tube Assembly ø1.2mm	Using on the top of Tip
20	Guide Tube Assembly ø1.4mm	Using on the top of Tip
21	Guide Tube Assembly ø1.6mm	Using on the top of Tip
22	Guide tube assembly ø0.6mm	Using on the bottom of Tip
23	Guide Tube Assembly ø0.8mm	Using on the bottom of Tip
24	Guide Tube Assembly ø1.0mm	Using on the bottom of Tip
25	Guide Tube Assembly ø1.2mm	Using on the bottom of Tip
26	Guide Tube Assembly ø1.4mm	Using on the bottom of Tip
27	Guide Tube Assembly ø1.6mm	Using on the bottom of Tip
28	Feeder Tube (0.46m) ø0.6mm	
29	Feeder Tube (0.46m) ø0.8mm	
30	Feeder Tube (0.46m) ø1.0mm	
31	Feeder Tube (0.46m) ø1.2mm	
32	Feeder Tube (0.46m) ø1.4mm	
33	Feeder Tube (0.46m) ø1.6mm	
34	Feeder Tube (0.8m) ø0.6mm	
35	Feeder Tube (0.8m) ø0.8mm	
36	Feeder Tube (0.8m) ø1.0mm	
37	Feeder Tube (0.8m) ø1.2mm	
38	Feeder Tube (0.8m) ø1.4mm	
39	Feeder Tube (0.8m) ø1.6mm	

and Soldering tip. Put a new Soldering tip on heating element, and tighten nut.

**△Note: To avoid scald, replacing when it cools down.**

## 2. Replace Fuse

- 1) Pull Power plug out of Power socket.
- 2) Take out the fuse holder on the rear side of the unit with screwdriver.
- 3) Remove the broken fuse and replace it with a new one
- 4) Fix the fuse holder.

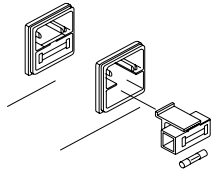

## SECTION 18 Replaceable Part

No.	Parts Name	Instruction
1	Pedal Switch	
2	Heating Element 90W	
3	Soldering Iron 90W	
4	Feeder Tube Assembly (0.46m) $\phi$ 0.6mm	
5	Feeder Tube Assembly (0.46m) $\phi$ 0.8mm	
6	Feeder Tube Assembly (0.46m) $\phi$ 1.0mm	
7	Feeder Tube Assembly (0.46m) $\phi$ 1.2mm	
8	Feeder Tube Assembly (0.46m) $\phi$ 1.4mm	
9	Feeder Tube Assembly (0.46m) $\phi$ 1.6mm	
10	Feeder Tube Assembly (0.8m) $\phi$ 0.6mm	
11	Feeder Tube Assembly (0.8m) $\phi$ 0.8mm	
12	Feeder Tube Assembly (0.8m) $\phi$ 1.0mm	
13	Feeder Tube Assembly (0.8m) $\phi$ 1.2mm	
14	Feeder Tube Assembly (0.8m) $\phi$ 1.4mm	

## SECTION 3 Character

- \* Iron soldering adopts high frequency heating, K type sensor, rapid heat and recovery speed to realize lead free solder. Many kinds of soldering tips with long service life can be optional and easy to use.
- \* Digital display, Button adjustment, digital calibration and design with automatic sleep function.
- \* Auto and Manual Feeding Mode optional and the times adjustable.
- \* Feeding Speed and Feeding Length and Feeding Interval Time adjustable, further more it is designed with Returning function to reduce solder wire consumption.
- \* Two kinds of Feeder Tube can be chose, and easier and more convenient to using. Long tube with Manual Touch Switch is suitable for active soldering. Short tube is suitable for fixed soldering.
- \* Both of Pedal switch and Manual switch can be use.
- \* It is used as Lead Feed Soldering Iron.
- \* ESD safe by design to avoid damaging sensitive element because of static.

## SECTION 4 Panel Picture

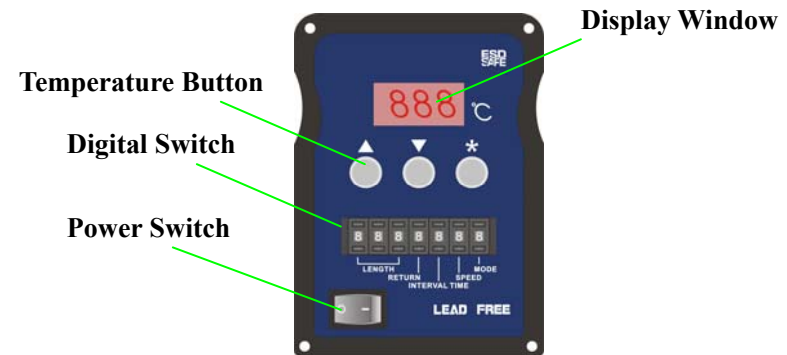

## SECTION 5 Combination

- \* Choose match Soldering Tip in accordance with Soldering Point.
- \* Choose Solder Wire Ring in accordance with Solder Wire diameter.
- \* Choose Feeder Tube in accordance with Solder Wire diameter
- \* Choose Guide Tube Assembly in accordance with Solder Wire diameter.

**NOTE: Please fix on Solder Wire diameter when purchasing the unit, in order to match Feeder Tube Assembly and Solder Wire ring exactly.**

## SECTION 6 Product picture and parts name

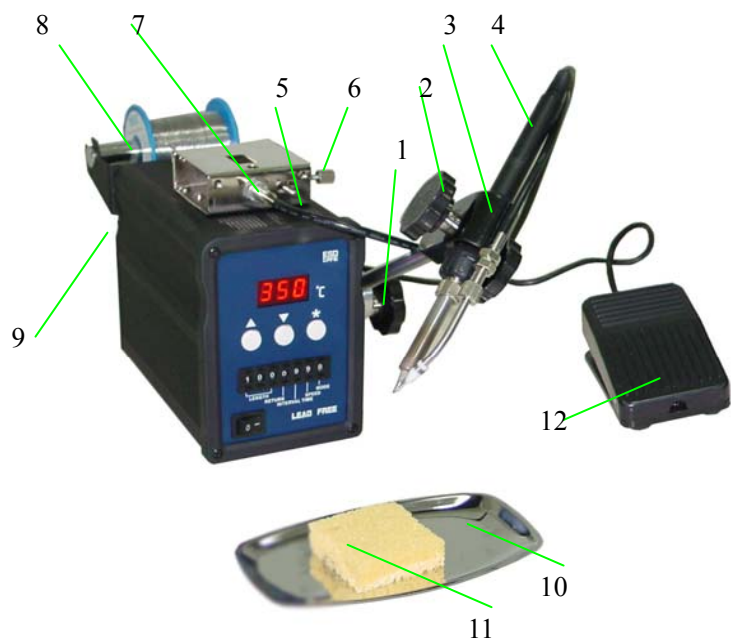

**Main Unit**

If the resistance value is not normal, replace the heating element. After replacing heating element, please check as follow.

1. Measure the resistance value between pins 4&1 or 2, pins 5&1 or 2, pins 6&1 or 2, pins 6&4 or 5. If it is not  $\infty$ , the heating element and sensor are touching. This will damage the P.W.B.
2. Measure the resistance value 'a', 'b', and 'c' to confirm that the lead wire are not twisted and that the grounding wire is properly connected.
3. To confirm that the clasp ⑨ is clasped with heating element ⑩.

Item No.	Part Name	Instruction
1	Nut	
2	Tip Enclosure	
3	Soldering Tip	Refer to the last page
4	Nip	Nipple
5	Cord Cover	
6	Handle Cover	
7	Handle	
8	Terminal Board	
9	Clasp	
10	Heater Combination	
11	Vibrator Switch	
12	Pin 6 Connector	Metal
13	Sensor Spring	
14	Heating Element	
15	Sensor Element	

## SECTION 17 Replaceable Part

Damageable part can be replaced by customers themselves.

### 1. Replace Soldering tip

Screw off the metal nut of Soldering tip anti-clockwise and remove tip enclosure

## SECTION 16 Check and replace Heating Element

Disconnect the plug and measure the resistance value between the connecting plug pins as follows:

If the values of 'a' and 'b' are outside the below value, replace the heating element (sensor) and /or cord assembly. If the value of 'c' is over the below value, remove the oxidization film by lightly rubbing with sand-paper or steel wool the points as shown.

a.	Between pins 4&5 (Heating Element)	Under 4 Ω (Normal)
b.	Between pins 1 & 2 (Sensor)	Under 10 Ω (Normal)
c.	Between pins 3 & Tip	Under 2 Ω

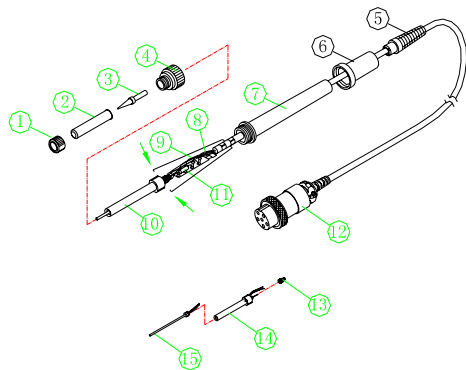
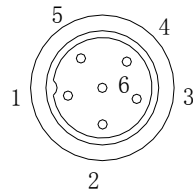

1. Turn the nut ① anticlockwise and remove the tip enclosure ② and the tip ③.
2. Turn the nipple ④ anticlockwise and remove it from the iron.
3. Pull Heating Element ⑩ out of Handle ⑦. (Toward the tip of the iron).
4. Do not use metal tools such as pliers to remove tip or Tip enclosure from the handle.

Measure when the heating element is at room temperature:

1. Resistance value of heating element (white) under 4 Ω .
- Resistance value of sensor (Red and Green ) under 10 Ω .

Feeder Tube Assembly (0.46m Short Tube)



Feeder Tube Assembly (0.8m Long Tube)

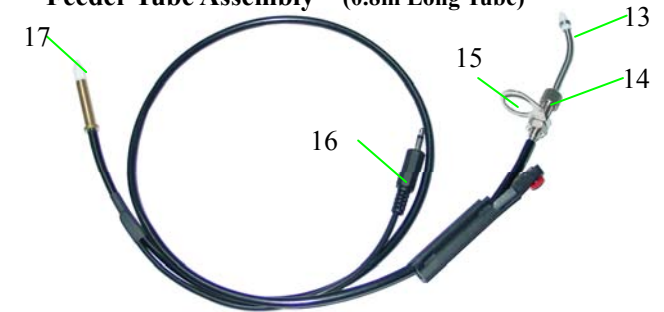

Feeder Tube (0.46m)



Feeder Tube (0.8m)

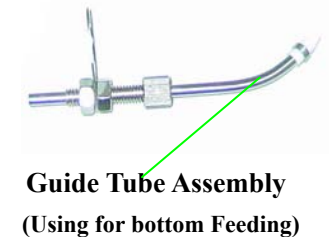
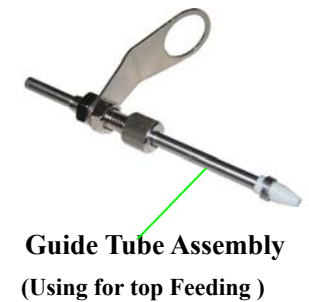

## Parts name:

### Main unit

Item No.	Part Name	Description
1, 2	Nut	Handle Bracket Assembly
3	Handle clamping element	Handle Bracket Assembly
4	Lead free soldering iron handle assembly	
5	Handspike	
6	Pressure adjusting screw	
7	Feeder tube assembly	Optional
8	Solder Wire Axis	Install Solder Wire
9	Solder Wire holder	Install Solder Wire Axis
10	Metal plate	
11	Cleaning sponge	
12	Pedal Switch	Optional Part

### Feeder Tube Assembly:

Item No.	Part Name	Remark
13	Guide Tube	
14	Locking Screw	
15	Connector	
16	Plug	
17	Feeder Tube Head	

loosing it, returning once and then stop working. Feeding Length and Feeding Interval and Feeding Mode are all useless when the Feeding Mode is set as manual.

### Auto:

Turn on Power Switch. The unit will work according to setting parameters when stepping on pedal switch or pressing Touch Switch once. All functions are useful

## SECTION 15 Tip care and use

1. Choose an appropriate temperature, too high temperature can weaken soldering tip function and accelerate oxidation and shorten its service life. Under the circumstance of able to work normally, choose the temperature as low as possible. Lower temperature can also solder adequately and protect sense elements. Suggest to set temperature to 350°C.
2. . Make sure set the temperature of soldering iron to 220°C when use first time. Make the soldering tip be tinned adequately. Best of all, dip it in tin for 5 minutes and then clean it with cleaning sponge, set the temperature to 300°C again. Repeat above steps. Finally set the temperature to work temperature. The purpose of this is to form a protecting film on tinned layer of soldering tip, so it can prevent the oxidation at high temperature and failure of heat transport.
3. If the tinned part of soldering tip has black oxide, it can be covered with new tin. Clean it with humid sponge repeatedly until the oxide is completely removed, and then covered with new tin. Please do this cleaning regularly.
4. Turn off the Power supply when not use. Clean the soldering tip with a cleaning sponge and then covered with new tin. Repeat above steps when use it again.
5. Replace soldering tip if it is twisted or eroded badly.

## SECTION 13 Temperature Calibration

The Soldering Iron's temperature should be recalibrated after replacing the iron or heating element or nozzle every time. The unit adopts digital calibration mode and the revision value is input by pressing button to make the adjustment simply and quickly.

Method of recalibrating temperature: Use the thermometer to calibrate , and it is precise comparatively.

### Calibrate by using thermometer

1. Set the unit's temperature to a certain value.
  2. When the temperature stabilizes, measure the tip's temperature with thermometer and write down the reading.
  3. Press “\*” button not loose and press the “▲” and “▼” button simultaneously, the unit enters into calibrating temperature mode.
  4. At the moment, the 100's digit of LED display temperature is flashing. Press the “▲” and “▼” button to select the value and press “\*” button to select the digit. Input the reading of thermometer, and inputting method is the same as **Set temperature normally**. Press “\*” button after inputting. Here, the whole calibration operation has been finished.
  5. If the temperature still has deflection, you can repeat calibration in accordance with above steps.
- \* We recommend to use the 191/192 thermometer for measuring the tip temperature.
- \* If the unit is locked by password, it will not be able to calibrate the nozzle temperature and you must input the right password.

## SECTION 14 Operation

Do corresponding operations in accordance with the chosen Feeding Mode.

**Manual:** (The Mode switch is set as 0)

Turn on power switch and LED window display temperature, the unit is in working state. Step on Pedal Switch or press the red Touch Switch, and the unit works. After

## SECTION 7 Installation

Before installation, please check the parts and make sure whether the power supply voltage accords with the nameplate.

### 1. Install Handle Bracket assembly to the unit

Screw off the Nut ① of the unit, install bracket assembly on the screw and screw down the Nut.

### 2. Install Feeder tube assembly

There are two types of feeder tube assembly optional: Length of 0.46m (Short Tube) and Length of 0.8m (Long Tube). Installation and operation have a little difference.

#### Installation of Short Tube:

Screw off the black nipple of handle assembly, install the handle into the connector and screw on the black nipple again. Unscrew the fixing screw of feeder tube head on the top cover of unit, insert feeder tube head ⑰ and then tighten the screw.

#### Installation of Long Tube:

Screw off the black nipple of handle assembly, install the handle into the connector and screw on the black nipple again. Unscrew the fixing screw of feeder tube head on the top cover of unit, insert feeder tube head ⑰ and then tighten the screw. Finally, insert plug ⑯ into socket behind the unit.

### 3. Install pedal switch

Put the plug of Pedal switch into pin-2 socket behind the unit.

### 4. Install Solder wire

- a. Pull the solder wire axis ⑧ across the framework of solder wire and place it to the solder wire holder ⑨ back of unit. Make the notch on each side of solder wire axis lock into solder wire holder.
- b. Pull the solder wire head and insert it into wire guide tube behind the top, push Handspike ⑤ to widen the gap between two running gear wheels, so it can cross the feeder tube easily.



- c. Set the **Mode Switch** as 0, insert power plug and turn on Power Switch . Make the feeder tube as straight as possibly, **step on Pedal Switch or press down the red Touch Switch** until the solder wire is sent out. Turn off power switch.

### 5.Install Soldering Iron

Screw off Nut ② on the bracket assembly and remove Handle clamping element ③. Place soldering iron in the other Handle clamping element and install the previous one (Make the Handle in the middle of them), and then screw on Nut ②. Connect plug of soldering iron handle to pin 6 receptacle in front of unit and tighten it.

### 6.Adjust the position of Guide tube and Soldering tip

Turn the Connector to change combination location of Guide tube and Soldering tip. Unscrew Locking Screw ⑭of Guide tube and turn around Guide tube ⑬ can also change combination location of Guide tube and soldering tip.

### 7.Adjust direction of soldering iron



When adjust direction, first unscrew the Nut of corresponding direction, and then adjust. Unscrew the Nut at the bottom end of Bracket assembly and turn around or rotate Bracket assembly can all adjust direction of Soldering Iron. Finally, tighten Nut after adjusting.

Unscrew two Nuts ① and ② on top end of Bracket simultaneously and turn around Handle clamping element can also adjust direction of Soldering Iron.

### ⚠NOTE:

Please be careful not to break heating element when screw off black nipple to install connector.

- If step on Pedal Switch or press down the red Touch Switch, the solder wire can't be sent out automatically, it needs to adjust feeding pressure—Pressure adjusting screw ⑥. Refer to parameter setting.
- The Feeder tube can't be bended overly avoiding the solder wire block.

1. If the display windows shows  , press and hold the “▲” or “▼” buttons simultaneously, then the display shows  . This indicates the unit comes into working mode setting state, and pressing “▲” or “▼” button will change displayed value as shown below:

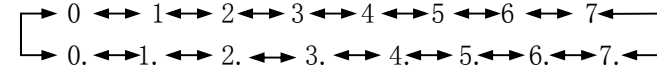

2. After selecting the working mode, press “\*” down. The working mode is stored into the internal memory. Please refer to the “Working Mode Table” for the meaning of the digit displayed.

Note: “X” represents original working mode digit.

**⚠Warning:** The heater and Soldering tips will be seriously oxidized or damaged when working with a high temperature. So please choose the working mode carefully and try to operate with a lower temperature if possible.

## SECTION 12 Sleeping

If sleeping and working mode are selected, and the unit is not used for 20 minutes, the power to the heating element will be decreased, and the display shows  . This state is sleeping mode. When the unit is in sleeping mode, the tip temperature will decrease to 200℃ (If the set temperature is more than or equal to 200℃) or 50℃ (If the set temperature is less than 200℃) and remain the temperature until resuming the unit. To resume soldering, there are several ways as follows:

1. Turn the power switch OFF, then ON.
2. Hit any button.
3. Take up the iron ——Hand Assembly

If the unit is not resumed more than 40 minutes after it comes to sleep, the power supply will be shut off automatically, and the display window will not show anything.

## Working Modes Table

WORK MODE	HANDLE MODE	TEMPERATURE RANGE	AVAILABLE FOR MAIN UNIT	AUTO SLEEPING&SWITCHING OFF
0	High frequency soldering iron	200℃-420℃	60W Station	Yes
1	High frequency soldering iron	200℃-420℃	90W Station	Yes
2	High frequency special very large	200℃-420℃	60 , 90W Station	Yes
3	High frequency tweezers stripper iron	50℃-600℃	90W Station	Yes
4	High frequency soldering iron	50℃-420℃	60W Station	Yes
5	High frequency soldering iron	50℃-420℃	90W Station	Yes
6	High frequency soldering iron	200℃-480℃	60W Station	Yes
7	High frequency soldering iron	200℃-480℃	90W Station	Yes
0.	High frequency soldering iron	200℃-420℃	60W Station	No
1.	High frequency soldering iron	200℃-420℃	90W Station	No
2.	High frequency tweezers or using	200℃-420℃	60, 90W Station	No
3.	High frequency tweezers stripper	50℃-600℃	90W Station	No
4.	High frequency soldering iron	50℃-420℃	60W Station	No
5.	High frequency soldering iron	50℃-420℃	90W Station	No
6.	High frequency soldering iron	200℃-480℃	60W Station	No
7.	High frequency soldering iron	200℃-480℃	90W Station	No

- When turn on the power Switch, the soldering Iron begin to heat up (Temperature lamp is light). In order not to be scalded, please be careful when installing.
- Make sure the power voltage in accord with working voltage of unit.

## SECTION 8 Set Parameter

### 1. Feeding Speed setting

Feeding speed is set with digital switch. Press “+” button on the digital switch and the match digit will increase by one step. Similarly, press “-” button, and the match digit will decrease by one step.

Feeding speed is designed with one digit. 0~9 denotes the feeding speed is about 2.7m/s~27m/s (Angle: 36°/s~360°/s).The resolution is 2.7mm/s, namely, each digit denotes feeding speed is 2.7m/s. (36°/s)

**Example:** When the digit is set as 0, the speed is slowest with 2.7mm/s. When it is set as 1, the speed is 5.4mm/s. When it is set as 9, the speed is fastest with 27mm/s.

Press the Speed Switch to set the suitable digit in accordance with working demand. The range is about 2.7mm/s to 27mm/s.

### 2. Feeding Length setting

Feeding Length is designed with angle system, namely, with angle what the motor turned denotes Feeding Length.

Feeding Length is designed with three digit. 001 to 999 denotes feeding length is 0.15mm to 150mm. The resolution is 0.15mm, namely, each digit denotes 0.15mm (1.8 degree). The setting method is the same as feeding speed.

**Example:** When the digit is set as 001, the angle is 1.8 degree and the Speed Length is 0.15mm. When the digit is set as 002, the angle is 3.6 degree and the Speed Length is 0.3mm. When the digit is set as 999, the Speed Length is longest with 150mm, and the angle is 1798.2 degree.

Press the Length Switch to set the suitable digit in accordance with working demand. The range is about 0.15mm to 150mm.

### 3. Feeding Interval Time setting

Feeding Interval Time means the interval time between every feeding when the automatic feeding over two times. Feeding Interval Time is designed with one digit. 0 to 9 denotes the interval time is 0 second to 2.7seconds. The resolution is 0.3 second, namely, each digit denotes 0.3 second. The setting method is the same as Feeding Speed.

**Example:** When the digit is set as 1, the interval time is 0.3 second. When it is set as 2, the interval is 0.6 second. When it is set as 9, the time is longest with 2.7 seconds.

Press the Interval Time Switch to choose the digit. The range is 0 second to 2.7 seconds.

### 4. Feeding Mode setting

Press the Feeding Mode Switch to choose suitable digit.

Feeding Mode is designed with one digit and the setting method is the same as above. The digital match function as follow:

0: Manual Feeding	1: Auto Feeding once
2: Auto Feeding twice	3: Auto Feeding three times
4: Auto Feeding four times	5: Auto Feeding five times
6: Auto Feeding six times	7: Auto Feeding seven times
8: Auto Feeding eight times	9: Auto Feeding nine times

After each feeding, it has returning.



### 5. Returning Time setting

Press Returning Switch to set the match digit in accordance with working demand.



Returning Time is designed with one digit. 0 to 9 denotes 0 second to 0.9 second. The resolution is 0.1 second, namely, each digit denotes 0.1 second. The returning speed is fixed with 360°/s.

**Example:** When the digit is set as 1, the returning time is 0.1 second and the returning length is 2.8mm. The digit is set as 2, the returning time is 0.2 second and the returning length is 5.6mm. When the digit is set as 9, the returning time is 0.9

### Input New Password

1. When display window is showing , press "\*" button, and shows , It indicates the unit comes into inputting new password state. Pressing "▲" or "▼" button will change displayed value. See "set temperature normally".

### Repeat the new password

2. When three digits are selected, press "\*" button, the display window shows  again. Now must input the new password. Repeat the same steps.
3. If the password is the same as last time, the changed password is OK. The new password is stored into the internal memory.
4. If the password is not the same as last time, and the display window shows , the station will need to rewrite new password. (see the last 8-9 step). The changing of password is finished until the lately two passwords are identical.

 **Note:** The word of password is from 0 to 9, ten words. If not , the changed password is unsuccessful.

## SECTION 11 Set Working Mode



The unit is design with many working modes When the unit leave factory, working mode is set as seven mode. User don't change this working mode optionally during using.

## SECTION 10 Set Password

Page 15

The initial password in station's memory is "000". The setting temperature is admitted in this state. If need to restrict the setting temperature, the password must be changed

### Enter into setting the password

1. Turn off the power switch. Press and hold the "▲" and "▼" buttons simultaneously, then turn on the power switch.
2. Continue holding down the "▲" and "▼" button until the display shows .
3. When the display shows , the station is in parameter-input mode.

### Input Previously Password

4. Press the "\*" button, the display shows , and the left-most digit (the 100's digit) in the display will flash. This indicates the station is in password setting mode and the 100's digit can be adjusted. Using the "▲" or "▼" button will change displayed value. Set the password value in the same way described in "set temperature normally". After selecting the password of three digit, press "\*" button.

### The input password is error

5. If the display window shows the present setting temperature, two seconds later, the station is in normal work state. This indicates the password of input is error, and the temperature setting can't be done.

### The password of input is correct

6. If the display window shows , this indicates the password of input is correct. After displaying about 4 seconds, the station comes into normal work state, and the setting temperature will be admitted.

second and the returning length is 25mm.

The range is about 0 to 25mm. (0 to 0.9s)

Page 14

### 6. Feeding Pressure setting

The solder wire isn't sent out automatically because of inadequate feeding pressure, you can adjust Pressure Adjusting Screw on top of unit to increase feeding pressure clockwise. Solder wire is twisted because of too strong feeding pressure, you can adjust it anticlockwise.

## SECTION 9 Set Temperature

### Set Temperature Normally

 **Caution:** Make sure the temperature of the station can be adjusted (password is OK or the password is initial). While setting the temperature normally, the heating element is off. If the "\*" button is pressed less than one second, the present temperature setting will be shown for two seconds and then the display will return to showing the tip temperature. "▲" and "▼" are choice button for value. "\*" is choice button for digit.

**Example: 400°C to 350°C**

- 1.

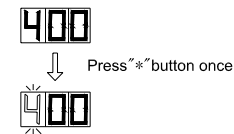

Press the "\*" button and hold it down for at least one second. The left-most digit (the 100's digit) in the display will flash. This indicates that the station is in temperature setting mode and that the 100's digit can be adjusted.

2.

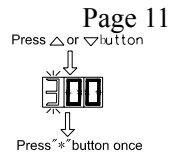

Select the desired value for 100's digit. Use the "▲" or "▼" button will change displayed value as follows.

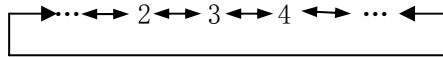

Press the "\*" button when the desired value is displayed. This will cause the middle digit (the 10's digit) in the display to begin flashing.

3.

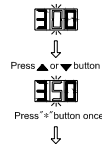

Select the desired value for the 10's digit. Using the "▲" or "▼" button will change the displayed value as shown below.

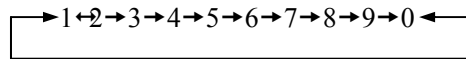

Press the "\*" button. The right (the 1's digit) will then begin flashing to indicate that the 1's digit can be set.

4.

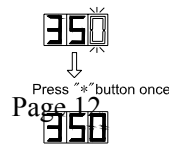

Select the desired value for the 1's digit. Using the "▲" or "▼" button will change the displayed value as shown above for the 10's place selection.. Press the "\*" button.

Here, pressing the "\*" button.....

- a. Enter the temperature setting into the internal memory.
- b. Display the temperature setting.
- c. Starts heater control.

**Note: If you turn off the power switch during the temperature setting, setting value will not be stored in the memory. If the temperature value outside of this range is selected, the display will return to flashing the 100's place. If this happens, reenter a correct temperature value**

### Set temperature on-line

In the work, if it is necessary to set temperature quickly and the heat elements can not be cut off, the way may be selected.

Temperature rising:

Don't press "\*" knob, and press "▲" knob directly. If so, the setting temperature will raise 1°C and the display window will display the set temperature. When loose the "▲" knob, the display window will delay the set temperature about 2 seconds. If within 2 seconds of time, press the "▲" knob again, the setting temperature will raise 1°C again. If press the "▲" knob and not loose at least 1 second, the setting temperature will rise rapidly. Till the needed temperature reaches, then loose the "▲" knob.

### Temperature dropping:

Don't press "\*" knob, and press "▼" knob directly. If so, the setting temperature will drop 1°C and the display window will display the set temperature. When loose the "▼" knob, the display window will relay the set temperature about 2 seconds. If within 2 seconds, press the "▼" knob again, the setting temperature will drop 1°C again. If press the "▼" knob and not loose at least 1 second, the setting temperature will drop rapidly. Till the needed temperature reaches, then loose the "▼" knob.