

# SENTRY

## SENTRY®

SENTRY OPTRONICS CORP.

# IRthermo-Anemometer

with built-in Infrared Thermometer

## Model-ST732

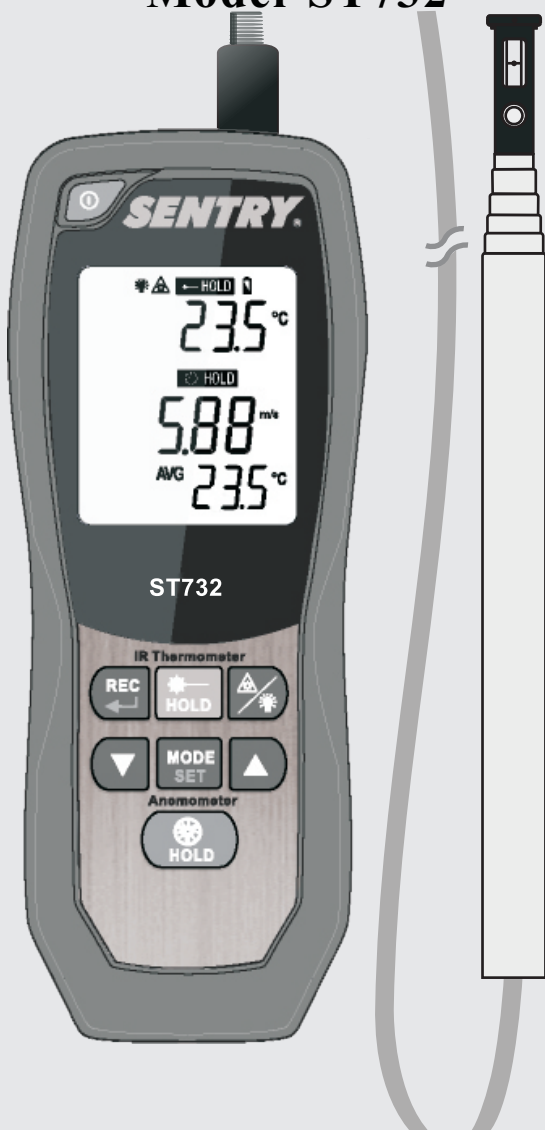

# Instruction Manual



# **IRthermo-Anemometer** **with built-in Infrared Thermometer**

# **Instruction Manual**

Ver.01 10/Aug.



# Table Content

<b>1. Product Introduction</b>	1
1-1 Features	1
1-2 Applications	2
<b>2. Safety Information</b>	2
2-1 Cautions	2
2-2 Safety Symbols	2
<b>3. Specifications</b>	4
3-1 General Specification	4
3-2 Technical Specification	5
<b>4. General Descriptions</b>	6
4-1 Unit Diagram	7
4-2 LCD Panel	7
4-3 Battery Placement	8
4-4 AC Power	8
4-5 Sensor Tip Description	10
<b>5. Mode Functions</b>	11
5-1 Air Velocity / Air Temperature Measurement	12
5-2 Air Flow Measurement	12
5-3 IR Thermometer Measurement	12
5-4 Maximum/Minimum/Average Measurement	13
5-5 Data Logger & Data Record / Recall	13
<b>6. Advanced Set Functions</b>	14
6-1 Air Velocity Setting	15
6-2 Air Flow Setting	15
6-3 IR Thermometer Setting	15
6-4 Sample Time of Data Log Setting	15
6-5 Clear Memory	15
6-6 Data / Time Setting	16
6-7 Laser and Backlight ON/OFF	16
<b>7. Communication</b>	16
<b>8. Techniques</b>	16
8-1 Useful Equations	16
8-2 Field Of View (FOV) And Distance & Spot Size (DS) Ratio	17
8-3 Emissivity	17
<b>9. Maintenance</b>	18

# 1. Product Introduction

Thank you for purchasing this IRthermo-Anemometer with built-in non-contact Infrared Thermometer. The IRthermo-Anemometer is an air velocity, air flow (volume), temperature of air, and non-contact infrared temperature measuring instrument. To measure an air velocity, put the sensor head face to the measurement air. Then the first reading will show the air velocity value. To measure a temperature, point the meter at a target until the temperature is read. (Make sure the target area is larger than the unit's spot size. For large target objects assure you are within target distance.)

## 1-1 Features

- Simultaneous display of air flow in CFM / CMM or air velocity plus ambient temperatures.
- Combination of hot wire and standard thermister , deliver rapid and precise measurements event at low air velocity.
- Wide range measurement of air velocity, fast response time.
- Multi-functions for air velocity measurement: m/s, km/h,ft/min, knots, mile/h.
- Infrared thermometer measures remote surface temperature to 932°F(500°C) with 8:1 distance to spot ratio and laser pointer
- Super large LCD with dual function display, read the air velocity & temperature at the same time.
- Real time data logger, build in clock (hour-min.-sec. , year-month-date).
- Data hold and record / recall maximum,minimum and average reading.
- Ultra low power consumption in shutdown mode.
- Auto power off after 10 minutes of idle (30 Minutes with AC Power)
- USB PC interface.

# 1-2 Applications

- Air conditioner
- Refrigerated case
- Ventilation system
- Furnace flow velocity
- Fans / motors / blowers
- Environmental testing
- Long distance temperature monitoring
- Manufacturing processes of semiconductor technology

## 2. Safety Information

Read the following safety information carefully before attempting to operate or service the meter. Only qualified personnel should perform repairs or servicing not covered in this manual.

### Laser Warning Note!



Do not point laser directly at eye. Use caution a round reflective surfaces. Keep out of reach of children.

## 2-1 Cautions!

- DO NOT submerge the unit in water.
- This product is not designed for use in medical evaluations. The product can only be used to measure body temperature simply for reference. They are meant for industrial and scientific purposes.

## 2-2 Safety symbols



Dangerous, refer to this manual before using the meter.



CE Certification

This instrument conforms to the following standards:

**EN61326:** Electrical equipment for measurement, control and laboratory use.

**IEC61000-4-2:** Electrostatic discharge immunity test.

**IEC61000-4-3:** Radiated, radio-frequency, electromagnetic field immunity test.

**IEC61000-4-8:** Power frequency magnetic field immunity test.

**IEC60825-1:** Safety.

**RoHS** Restrict to use of six substances within electrical and electronic equipment (EEE), thereby contributing to the protection of human health and the environment.



The device may not be disposed of with the trash. It promotes the re-use recycling and other forms of recovery of used materials and components, and to improve the environmental performance of all operators (manufacturers, traders and treatment facilities) involved in the life cycle of products. Dispose of the product appropriately in accordance with the regulations in force in your country

### **REACH (SVHC)**

The device of used materials content no following substances that list of proposed REACH substances of very high concern .

# 3. Specification

## 3-1 General Specification

Measurement	Air Velocity : m/s, ft/min, km/h, mile/h ,knots Air Flow : CMM(m <sup>3</sup> /min), CFM(ft <sup>3</sup> /min) Temperature : °C and °F
Sensors	Air Velocity / Air Flow Sensor : Hot wire Infrared sensor : Thermopile
Operating Temp.	0~50°C(32~122°F),10~90%RH
Storage Temp.	-10~60°C( 14~140°F)
Sample Time	Approx. 0.5 sec.
Data Logging	YES (20000 points)
Record Function	YES (9 points)
Time Interval	YES
PC Interface	YES
AC Power	YES
Multi-LCD Display	YES
Max / Min / Avg	YES
LCD Backlight	YES
Data Hold	YES
Weight	Approx. 320g (11.3 oz.)
Auto Power Off	10 Minutes of idle (30 Minutes with AC Power)
Dimensions	184×70×40mm (7.24"×2.75"×1.57") Telescope probe: approx. 1800mm (70.8inch)include wire rod.
Accessories	9V Battery, Instruction manual, Carrying case, AC Input, USB Transmission line, PC Interface window-bace software.



## 3-2 Technical Specification

Range	<p>Air Velocity: 0~40m/s, 0~7874ft/min, 0~144km/h, 0~89.5mile/h, 0~77.75knots</p> <p>Air Flow: 0~72,000 CMM (m<sup>3</sup>/min), 0~2,542,700 CFM (ft<sup>3</sup>/min)</p> <p>Air Flow(Area):0.001~30m<sup>2</sup>, 0.01~322.92ft<sup>2</sup></p> <p>Air Temperature: 0~70°C(32~158°F)</p> <p>Temperature:-32~537.5°C(-25~999°F)</p>
Resolution	<p>Air Velocity : 0.01m/s, 0.1ft/min, 0.01km/h, 0.01mile/h, 0.01knots</p> <p>Air Flow : 1CMM ; 1CFM (0~99999 CFM), 10CFM (100000~999990 CFM), 100CFM (1000000~1907000 CFM),</p> <p>Air Flow(Area) : 0.001m<sup>2</sup>(0.01ft<sup>2</sup>)</p> <p>Air Temperature : 0.1°C(0.1°F)</p> <p>Temperature : 0.1°C(0.1°F)</p>
Accuracy (%reading)	<p>Air Velocity : ±(0.03+3%)m/s, ±(5.9+3%)ft/min, ±(0.11+3%)km/h,±(0.07+3%)mile/h, ±(0.06+3%)knots</p> <p>Air Flow: 1.8 m<sup>3</sup>/min + ±3% of reading</p> <p>Temperature : ±3.0°C(±5.4°F) from -32~-20°C(-25~-4°F), ±2.0°C(±3.6°F) from -20~100°C(-4~212°F), ±2% from 100~537.5°C(212~999°F)</p>
Emissivity	0.95 fixed
Distance/Spot Ratio	8 : 1

# 4. General Descriptions

## 4-1 Unit Diagram

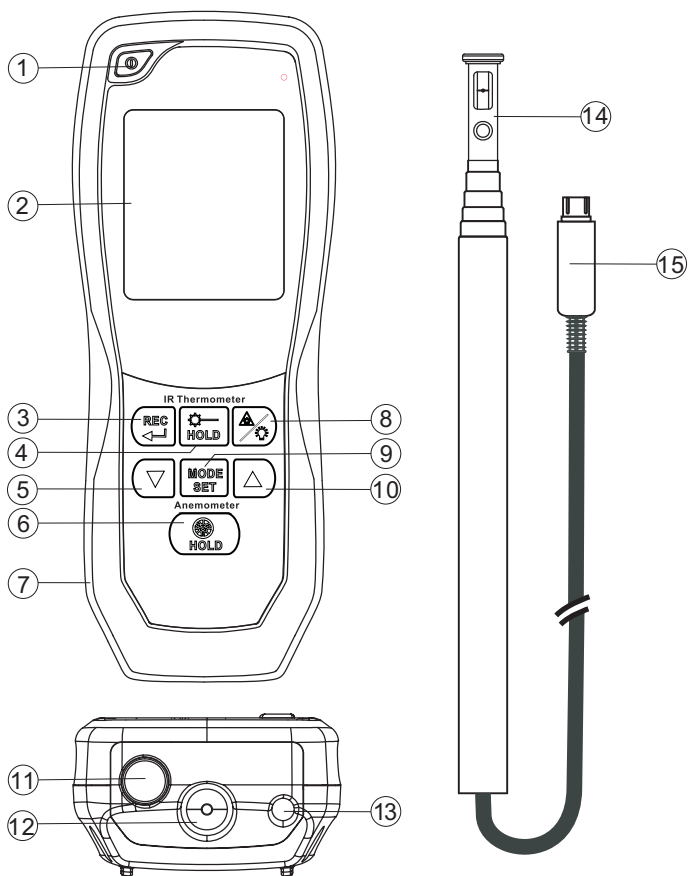

- 
- |                              |                     |
|------------------------------|---------------------|
| ① Power Button               | ⑨ MODE (SET) Button |
| ② LCD Screen                 | ⑩ ▲ Up Button       |
| ③ REC (←) Button             | ⑪ Probe Socket      |
| ④ IR Thermometer Hold Button | ⑫ Measuring Window  |
| ⑤ ▼ Down Button              | ⑬ Laser Sighting    |
| ⑥ Anemometer Hold Button     | ⑭ Sensor Head       |
| ⑦ AC Input Terminal          | ⑮ Probe Plug        |
| ⑧ Laser / Backlight Button   |                     |

## 4-2 LCD Panel

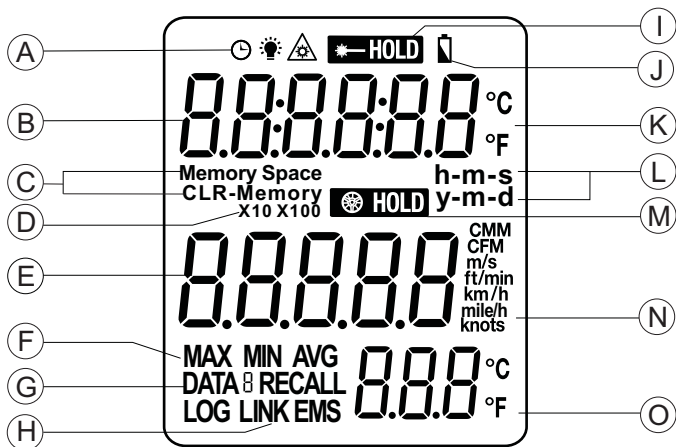

- |                                       |                         |
|---------------------------------------|-------------------------|
| (A) Time Interval / Laser / Backlight | (I) IR Thermometer Hold |
| (B) Secondary Reading                 | (J) Low Battery         |
| (C) Memory Space / Clear Memory       | (K) IR Thermometer Unit |
| (D) X10 / X100                        | (L) Time / Date         |
| (E) Primary Reading                   | (M) Anemometer Hold     |
| (F) MAX / MIN / AVG                   | (N) Anemometer Unit     |
| (G) DATA Record / Recall / Log        | (O) Tertiary Reading    |
| (H) PC Link / EMS                     |                         |

## 4-3 Battery Change

The meter is powered by a 9V battery. When  symbol appear, the battery voltage drops below the level for reliable operation, the user has to replace a new battery. To change the battery, open the battery cover on the back and replace the battery in the battery compartment. Make sure the cover is well snapped after the replacement of battery.

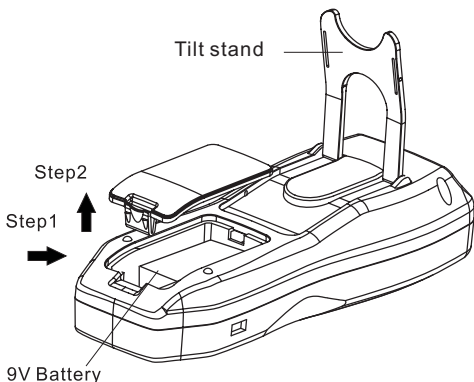

## 4-4 AC Power

Except battery power supply, the unit also consumes AC power via USB cable:

- Plug "A" male of the cable into "A" receptacle of the AC adapter included in the package (Fig. 1) and plug mini "B" male into the mini "B" receptacle of the unit.
- Plug the AC adapter to the wall jack (Fig. 2) Option.
- Plug "A" male into PC or Notebook USB port (Fig. 3).

- AC Plug with interchangeable PIN  
(Please see specification)

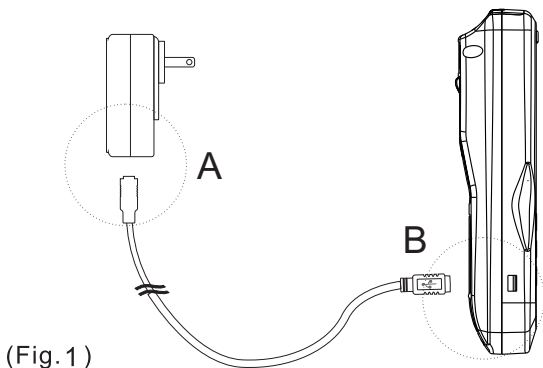

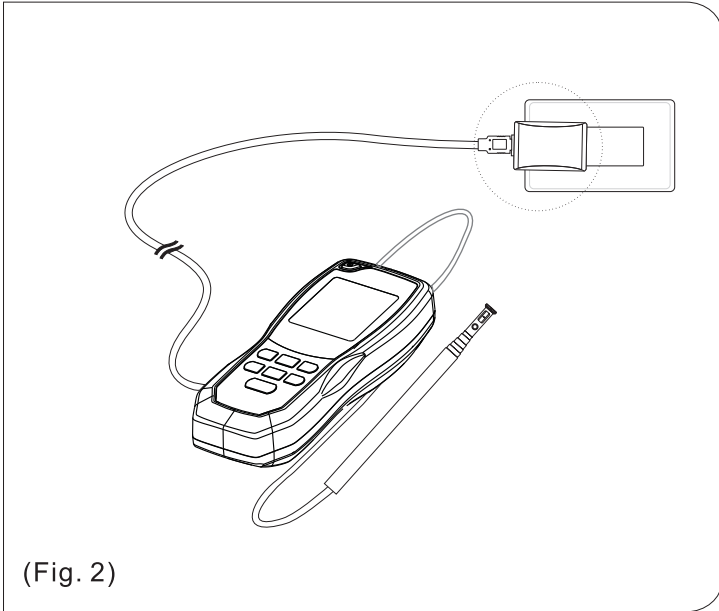

(Fig. 2)

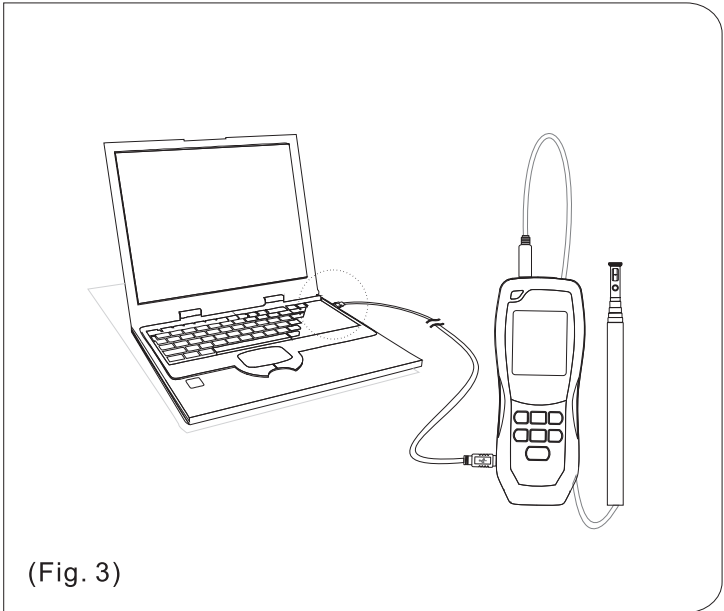

(Fig. 3)

## 4-5 Sensor Tip Description

### • Sensor Head:

Measurement

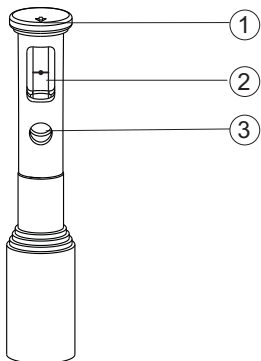

Not in Use

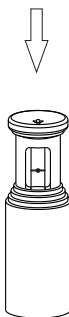

- ① Air Direction Arrow
- ② Air Velocity Sensor  
(Do not touch !)
- ③ Temperature Sensor

To protect the sensors, please telescope the sensor head into the wand when the meter is not in use.



**Warning!** Do not touch the air velocity or temperature thermistor inside the sensor head.

**Air Velocity Measurement:** Place the sensor in the air current to be measured. Have the air flow meet the sensor head in the direction toward the arrow.

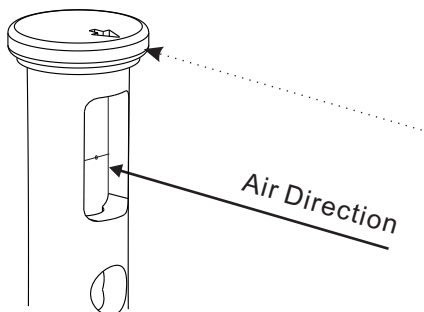

## 5. Mode Function

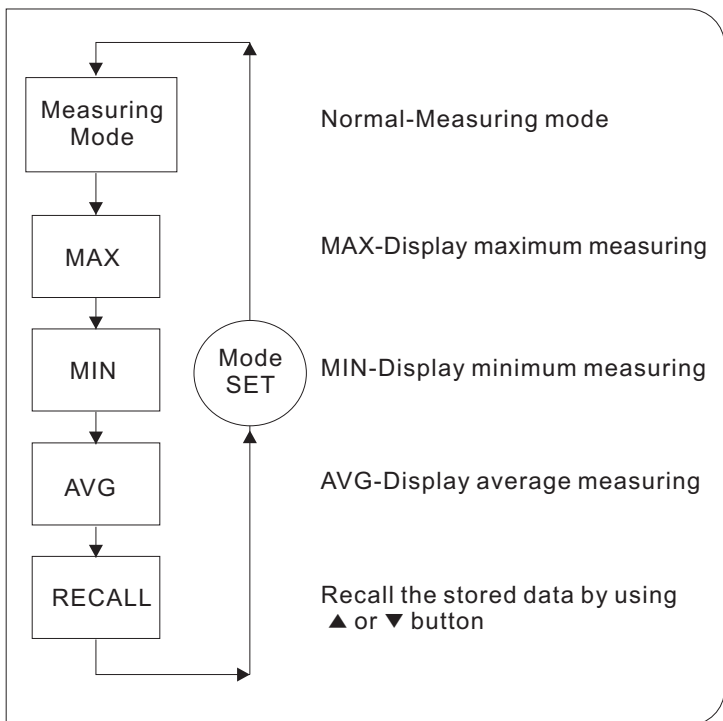

It is easy to operate more measurement functions by using “MODE SET” button to change. The sequential operations and explanations are shown in the following flow-chart.

### Mode Function

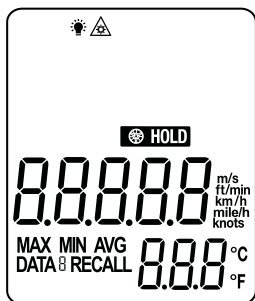

## 5-1 Air Velocity / Air Temperature Measurement





The meter works in air velocity measuring mode (please refer to chapter 6-1). Place the sensor in the air stream. It will show the air velocity value on the primary reading and show the air temperature value on the tertiary reading. During measuring, press the “” button once to hold the air velocity value and the “” symbol will appear on the LCD.

Press the button again to return to normal operation.

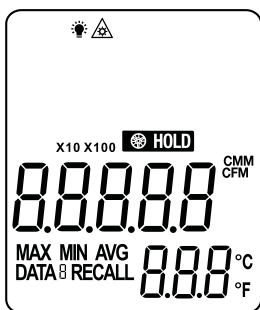

## 5-2 Air Flow / Air Temperature Measurement

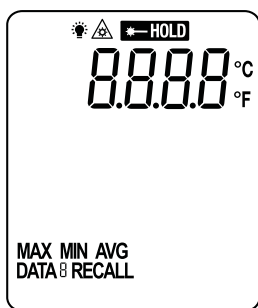

The meter works in air flow measuring mode (please refer to chapter 6-2). Place the sensor in the air stream. It will show the air flow value in the primary reading and show the air temperature value in the tertiary reading. During measuring, press the “” button once to hold the air flow value and the “” symbol will appear on the LCD. Press the button again to return to normal operation.

## 5-3 Non-contact Infrared Thermo- meter Measurement



The meter works in temperature measuring mode. Point the meter at a target and it will show the temperature value on the secondary reading. During measuring, press the “” button once to hold the temperature value and the “” symbol will appear on the LCD. Press the button again to return to normal operation.



## 5-4 Maximum / Minimum / Average Measurement

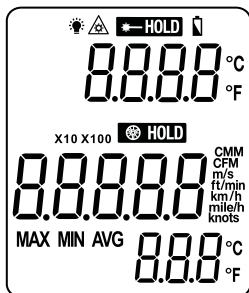

In measuring mode, press the “MODE SET” button to toggle the “MAX/MIN/AVG” mode and measure a target, it will show the MAX/MIN/AVG air velocity (flow) value on the primary reading and show the MAX/MIN/AVG temperature value on the secondary reading.

During measuring, press the “HOLD” / “HOLD” button once to hold the measured value and the “HOLD” / “HOLD” symbol will appear on the LCD. Press the button again to return to normal operation and the MAX/MIN value will reset.

## 5-5 Data Logger & Data Record / Recall

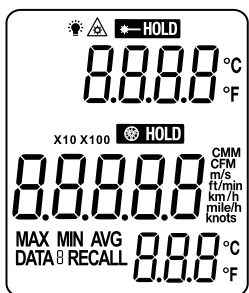

### Data Record:

The data can be recorded in the measuring mode function. Just press “REC” button once, the value on the primary, secondary and tertiary readings will be recorded in DATA# and automatically point to next address DATA#+1.

### Data Recall:

Press the “MODE SET” button to select the recall mode and the “RECALL” symbol will appear on the LCD. Press the “▲” or “▼” button to recall the stored data. At the DATA 0, press “REC” button to clear the DATA1 to DATA9.

### Data Logger:

The data logger function can save 20,000 measuring data automatically by preset the sample time. Press the “REC” button and hold for 3 seconds to start the data logger function in any measuring mode and the “LOG” symbol will appear on the LCD. Repeat to press the “REC” button and hold for 3 seconds again to exit this function.



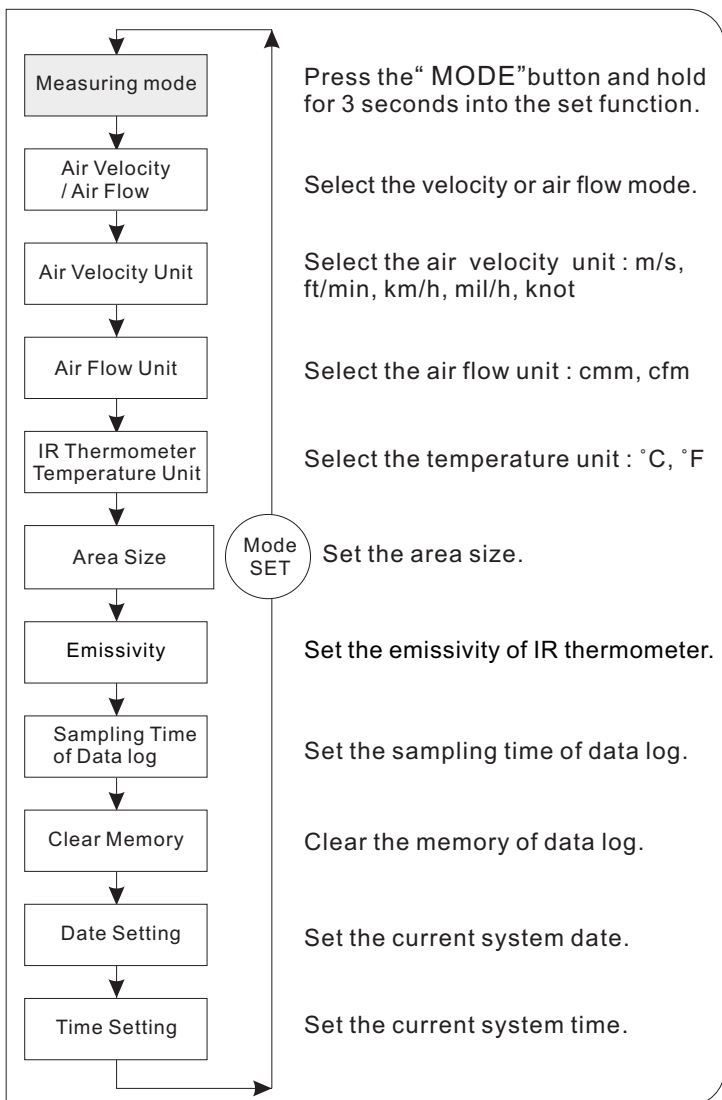

## 6. Advanced Set Functions

Press the “**MODE SET**” button and hold for 3 seconds into the advanced set function. Repeat to press the “**MODE SET**” button and hold for 3 seconds again or idle for 6 seconds to exit this function. In the set function, press the “**▲**” or “**▼**” button to adjust, press the “**MODE SET**” button to set and automatically toggle to next options. The sequential operation and explanations are shown in the following flow-chart.





### Advanced set functions







## 6-1 Air Velocity Setting

- **Air Velocity / Flow mode:** Press the “” or “” button to select mode. All of unit symbols in the same mode will flash on the LCD.
- **Air Velocity Unit:** Press the “” or “” button to select the air velocity unit. The unit symbol will flash on the LCD.





## 6-2 Air Flow Setting

- **Air Flow Unit:** Press the “” or “” button to select the air flow unit. The unit symbol will flash on the LCD.
- **Area Size:** Press the “” or “” button to adjust the size within 0.001 to 30.000 m<sup>2</sup>(0.01 to 322.92 ft<sup>2</sup>). The value will flash on the LCD.

## 6-3 IR Thermometer Setting

- **Temperature Unit:** Press the “” or “” button to select the °C or °F unit. The unit symbol will flash on the LCD.
- **Emissivity:** The “EMS” symbol will appear on the LCD. Press the “” or “” button to adjust the EMS within 0.10 to 1.00 and the value will flash on the LCD.



## 6-4 Time of Data Log Setting



- **Time of Data Log:** The  and “DATA LOG” symbols will appear on the LCD. Press the “” button to select the minute or second to set. The selected time unit will flash on the LCD. Press the “” or “” button to set the time.

## 6-5 Clear Memory

- **Clear Memory:** The “Memory Space” symbol will appear on the LCD. Press the “” button to erase the entire memory of data logger. The “CLR-Memory” symbol will appear and flash on the LCD.

## 6-6 Date / Time Setting

• **Date Setting:** The ☹ and “y-m-d” symbols will appear on the LCD. Press the “” button to select the year, month or date to set. The selected unit will flash on the LCD. Press the “” or “” button to set the current system date.

• **Time Setting:** The ☹ and “h-m-s” symbols will appear on the LCD. Press the “” button to select the hour, minute or second to set. The selected unit will flash on the LCD. Press the “” or “” button to set the current system time.

## 6-7 Laser and Backlight ON/OFF

• **Laser / Backlight Setting:** Press the “” button to turn the laser or backlight on and off.

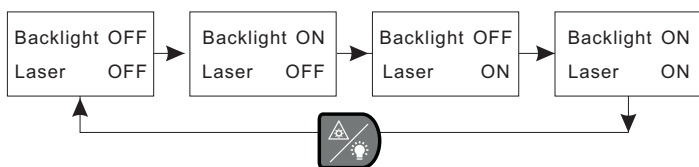

## 7. Communication

The IRthermo-Anemometer is equipped with a communication jack on its underside. The supplied communications cable connects to this jack and to a USB port on a PC. The supplied software allows the user to view and save readings to the PC. Instructions for operations and features are detailed in the supplied software HELP utility.

## 8. Techniques

### 8-1 Useful Equations

• **Area equation for rectangular or square ducts:**



H(Height)

$$\text{Area} = W(\text{Width}) \times H(\text{Height})$$

W(Width)

• **Area equation for circular ducts:**

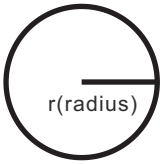

$$\text{Area} = 3.14 \times r(\text{radius})^2$$

• **Cubic equation:**

$$\text{CMM}(\text{m}^3/\text{min.}) = \text{Air Velocity}(\text{m/s}) \times \text{Area}(\text{m}^2) \times 60$$

$$\text{CFM}(\text{ft}^3/\text{min.}) = \text{Air Velocity}(\text{ft/m}) \times \text{Area}(\text{ft}^2)$$

## 8-2 Field Of View (FOV) And Distance To Spot Size (DS) Ratio

The field of view is the angle of vision at which the instrument operates, and is determined by the optics of the unit. The FOV is the ratio of the distance from the target to the target diameter. The smaller the target, the closer you should be to it. When the target diameter is small, it is important to bring the thermometer closer to the target to insure that only the target is measured, excluding the surroundings.

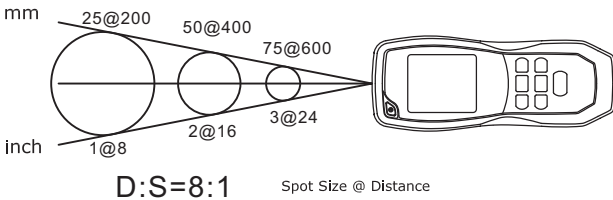

## 8-3 Emissivity

Emissivity is the ability of an object to emit or absorb energy. Perfect emitters have an emissivity of 1, emitting 100% of incident energy. An object with an emissivity of 0.8 will absorb 80% and reflect 20% of the incident energy. Emissivity is defined as the ratio of the energy radiated by an object at a given temperature to the energy emitted by a perfect radiator at the same temperature. All values of emissivity fall between 0.95 fixed.

Non-contact temperature sensors measure IR energy emitted by the target, have fast response, and are commonly used to measure moving and intermittent targets, targets in a vacuum, and targets that inaccessible due to hostile environments, geometry limitations, or safety hazard. The cost is relatively high, although in some cases is comparable to contact devices.

## 9. Maintenance

Cleaning the lens: Blow off loose particles using clean compressed air. Gently brush remaining debris away with a camel's hair brush. Carefully wipe the surface with a moist cotton swab. The swab may be moistened with water.

### **NOTE:**

DO NOT use solvents to clean the glass lens.

### **Cleaning the housing:**

Use soap and water on a damp sponge or soft cloth.

# Emissivity Table

Material	Temp °C/°F	Emissivity
Gold(pure highly polished)	227/440	0.02
Aluminum foil	27/81	0.04
Aluminum disc	27/81	0.18
Aluminum household(flat)	23/73	0.01
Aluminum (polished plate 98.3%)	227/400	0.04
	577/1070	0.06
Aluminum(rough plate)	26/78	0.06
Aluminum(oxidized @599°C)	199/390	0.11
	599/1110	0.19
Aluminum surfaced roofing	38/100	0.22
Tin(bright tinned iron sheet)	25/77	0.04
Nickel wire	187/368	0.1
Lead(pure 99.95-unoxidized)	127/260	0.06
Copper	199/390	0.18
	599/1110	0.19
Steel	199/390	0.52
	599/1110	0.57
Zinc galvanized sheet iron(bright)	28/82	0.23
Brass(highly polished):	247/476	0.03
Brass(hard rolled-polished w/lines):	21/70	0.04
Iron galvanized(bright)	-	0.13
Iron plate(completely)	20/68	0.69
Rolled sheet steel	21/71	0.66
Oxidized iron	100/212	0.74
Wrought iron	21/70	0.94
Molten iron	1299-1399/3270-2550	0.29
Copper(polished)	21-117/70-242	0.02
Copper(scraped shiny not mirrored)	22/72	0.07
Copper(Plate heavily oxidized)	25/77	0.78
Enamel(white fused on iron)	19/66	0.9
Formica	27/81	0.94
Frozen soil	-	0.93
Brick(red-rough)	21/70	0.93
Brick(silica-unglazed rough)	1000/1832	0.8
Carbon(T-carbon 0.9% ash)	127/260	0.81
Concrete	-	0.94
Glass(smooth)	22/72	0.94
Granite(polished)	21/70	0.85
Ice	0/32	0.97
Marble(light gray polished)	22/72	0.93
Asbestos board	23/74	0.96
Asbestos paper	38/100	0.93
	371/700	0.95
Asphalt(paving)	4/39	0.97











***SENTRY***®

**SENTRY OPTRONICS CORP.**

3F, No.122, Sec.1, Sanmin Road,  
Ban-Ciao, Taipei 220, Taiwan, R.O.C.

TEL:886-2-2956-8198

FAX:886-2-2956-7662

<http://www.sentrytek.com.tw>

PA05-0000732-01 ST-732 Ver. 01 10/Aug.