

# INSTRUCTION MANUAL

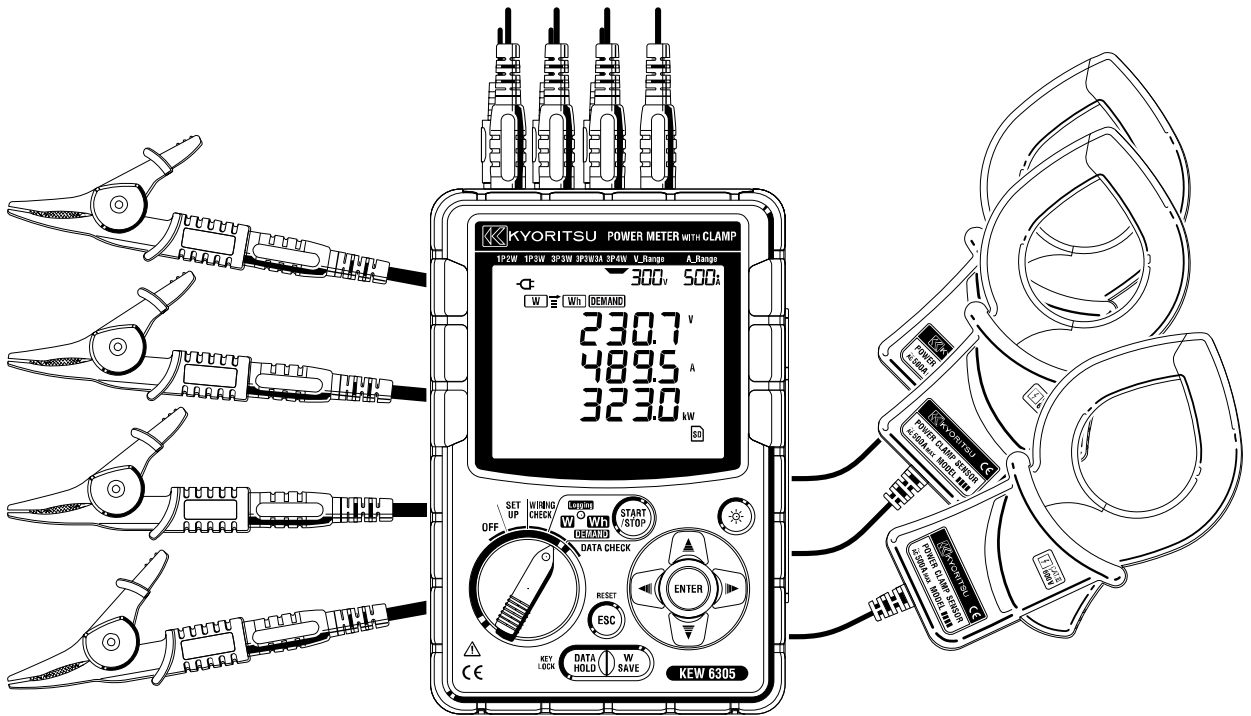

---

## DIGITAL POWER METER

---

**KEW 6305**



**Kyoritsu Electrical Instruments Works, Ltd.**

- Unpacking procedure

We thank you for purchasing our digital Power Meter **KEW6305**. Please check the contents and instrument before use.

- Items listed below are included with the standard set:

1	Main unit	KEW6305: 1 unit
2	Voltage test lead	MODEL7141B:1 set (RED, GREEN, BLUE, BLACK: 1 pce for each)
3	Power cord	MODEL7170: 1 pce
4	USB cord	MODEL7148: 1 pce
5	Quick manual	1 pce
6	CD-ROM	1 pce
7	Battery	Alkaline size AA battery (LR6): 6pcs
8	SD Card	1 pce
9	Carrying case	MODEL9125: 1 pce

Optional parts

10	Clamp sensor	Depending on model purchased
11	Instruction manual for Clamp sensor	1 pce
12	SD Card	2GB
13	Carrying case for Main unit	MODEL9132
14	Power supply adapter	MODEL8312

1. Main unit

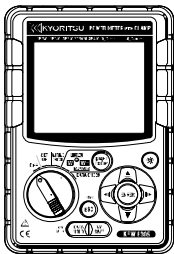

2. Voltage test lead

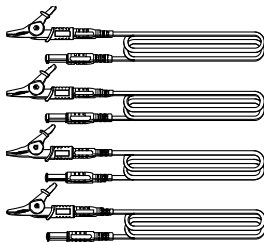

3. Power cord

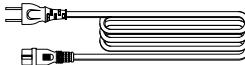

4. USB cord

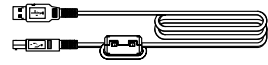

5. Quick manual



6. CD-ROM

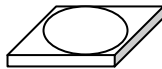

7. Battery



8. SD Card



9. Carrying case

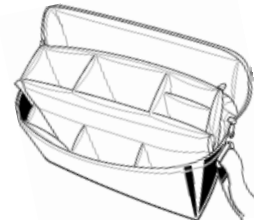

**10. Clamp sensor**  
(depending on model purchased)



50A type ( $\Phi$ 24mm)	M-8128
100A type ( $\Phi$ 24mm)	M-8127
200A type ( $\Phi$ 40mm)	M-8126
500A type ( $\Phi$ 40mm)	M-8125
1000A type ( $\Phi$ 68mm)	M-8124
3000A type ( $\Phi$ 150mm)	M-8129

**11. Instruction manual for Clamp sensor**

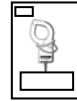

**12. SD Card**

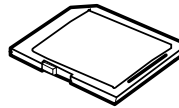

2GB	M-8326-02
-----	-----------

**13. Carrying case for main unit (with magnet)**

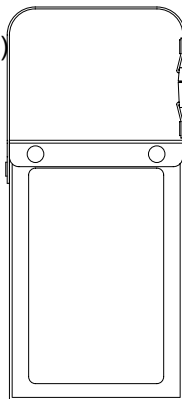

**14. Power supply adapter**

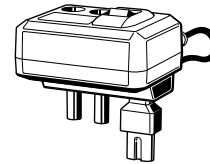

**● Storage**

Store the items as shown below after use.

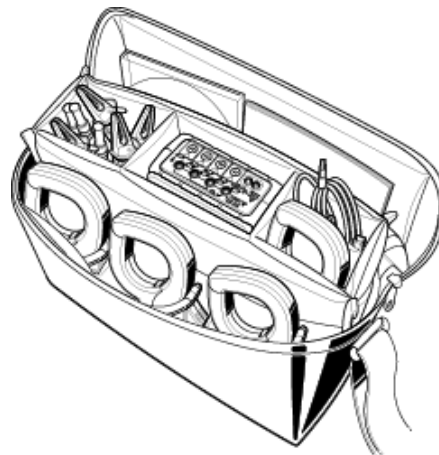

● In case any of the items listed above are found to be damaged or missing or if the printing is unclear, please contact your local KYORITSU distributor.

## ● Safety warnings

This instrument has been designed, manufactured and tested according to IEC 61010-1: Safety requirements for Electronic Measuring apparatus, and delivered in the best condition after passing quality control tests.



**This instruction manual contains warnings and safety procedures which have to be observed by the user to ensure safe operation of the instrument and to maintain it in safe condition. Therefore, read through these operating instructions before using the instrument.**



### **WARNING**

- For about Instruction manual -

- Read through and understand the instructions contained in this manual before using the instrument.
- Keep the manual at hand to enable quick reference whenever necessary.
- The instrument is to be used only in its intended applications.
- Understand and follow all the safety instructions contained in the manual.
- Read the enclosed Quick manual after reading this instruction manual.
- As to the Clamp sensor use, refer to the instruction manual supplied with the sensor.

It is essential that the above instructions are adhered to. Failure to follow the above instructions may cause injury, instrument damage and/or damage to equipment under test.

The symbol  indicated on the instrument, means that the user must refer to the related parts in the manual for safe operation of the instrument. It is essential to read the instructions wherever the  symbol appears in the manual.

- |   |                |  |
|---|----------------|--|
|   | <b>DANGER</b>  | : is reserved for conditions and actions that are likely to cause serious or fatal injury. |
|  | <b>WARNING</b> | : is reserved for conditions and actions that can cause serious or fatal injury.           |
|  | <b>CAUTION</b> | : is reserved for conditions and actions that can cause injury or instrument damage.       |

## O Measurement Category

To ensure safe operation of measuring instruments, IEC 61010 establishes safety standards for various electrical environments, categorized as O to CAT.IV, and called measurement categories. Higher-numbered categories correspond to electrical environments with greater momentary energy,

so a measuring instrument designed for CAT.III environments can endure greater momentary energy

than one designed for CAT.II.

O : Circuits which are not directly connected to the mains power supply.

CAT.II : Electrical circuits of equipment connected to an AC electrical outlet by a power cord.

CAT.III : Primary electrical circuits of the equipment connected directly to the distribution panel, and feeders from the distribution panel to outlets.

CAT.IV : The circuit from the service drop to the service entrance, and to the power meter and primary overcurrent protection device (distribution panel).

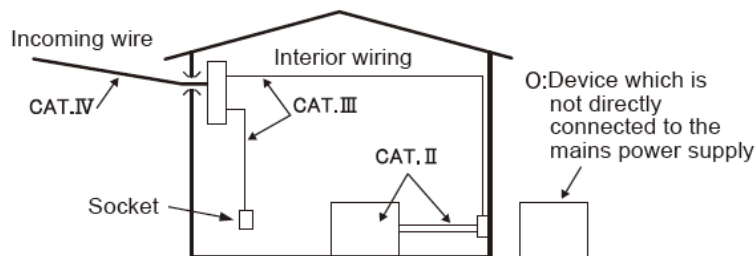

 **DANGER**

- Verify proper operation on a known source before use.
- Verify proper operation on a known source before taking action as a result of the indication of the instrument.
- Never make measurement on a circuit in which the electrical potential exceeds 600VAC.
- Do not attempt to make measurement in the presence of flammable gasses. Otherwise, the use of the instrument may cause sparking, which can lead to an explosion.
- Never attempt to use the instrument if its surface or your hand is wet.

**- Measurement -**

- Do not exceed the maximum allowable input of any measuring range.
- Never open the Battery cover during a measurement.

**- Battery -**

- Do not try to replace batteries during a measurement.
- Brand and type of the batteries to be used should be harmonized.

**- Power cord -**

- Connect the Power cord mains plug to a mains socket outlet.
- Use only the Power cord supplied with this instrument.

**- Power supply connector -**

- Never touch the Power supply connector although it is insulated while the instrument is operating with batteries.

**- Voltage test leads -**

- Use only the ones supplied with this instrument.
- Confirm that the measured voltage rating of the test lead is not exceeded.
- Do not connect a Voltage test lead unless required for measuring the parameters desired.
- Connect Voltage test leads to the instrument first, and only then connect them to the circuit under test.
- Never disconnect Voltage test leads while the instrument is in use.
- Connect to the downstream side of a circuit breaker since a current capacity at the upstream side is large.
- Do not touch two lines under test with the metal tips of the test leads.
- Never touch the metal tips of the test leads.

**- Clamp sensor -**

- Use only the ones dedicated for this instrument.
- Confirm that the measured current rating of the test lead is not exceeded.
- Do not connect a Camp sensor unless required for measuring the parameters desired.
- Connect sensors to the instrument first, and only then connect them to the circuit under test.
- Never disconnect sensors while the instrument is in use.
- Connect to the downstream side of a circuit breaker since a current capacity at the upstream side is large.
- Do not touch two lines under test with the metal tips of the test leads.

 **WARNING**

**- Connection -**

- Confirm that the instrument is off, and then connect the Power cord.
- Connect the Power cord, Voltage test leads and Clamp sensors to the instrument first. Cord to be firmly inserted.
- Never attempt to make any measurement if any abnormal conditions, such as a broken cover or exposed metal parts are present on the Instrument, Voltage test leads, Power cord and Clamp sensor.

**- Measurement –**

- Ensure that the Current input terminal cover, USB connector cover and SD card connector cover are closed when not in use during a measurement.

**- Not in use for a long period -**

- Remove the Power cord from the outlet if the instrument will not be in use for a long period.

**- Repair/ Calibration -**

- Do not install substitute parts or make any modification to the instrument. Return the instrument to your local KYORITSU distributor for repair or re-calibration in case of suspected faulty operation.

**- Battery -**

- Do not try to replace the batteries if the surface of the instrument is wet.
- Ensure that the Power cord, Voltage test leads and Clamp sensor are removed from the instrument, and that the instrument is switched off when opening the Battery cover for battery replacement.
- Never mix new and old batteries.
- Install batteries in correct polarity as marked inside the Battery compartment area.

**- Power cord -**

- Do not use the damaged cord.
- Don't put heavy things on, step on or pinch the cord, moreover, not to touch any heating material.
- When unplugging the cord from the mains socket outlet, do so by removing the plug first and not by pulling the Power cord.

**- Measures against abnormal symptoms -**

- If the instrument begins to emit smoke, becomes too hot, or gives off an unusual smell, immediately power it off and disconnect the power cord from the outlet. Also power off the power to the object under test. If any anomalies as noted, contact your local KYORITSU distributor.

**- Use of protective gears -**

- Use insulated gloves, boots or head gears at measurements to ensure user's safety.

 **CAUTION**

- Caution should be taken since conductors under test may be hot.
- Never apply currents or voltages exceeding the maximum allowable input for the instrument for a long time.
- Do not apply currents or voltages for the Voltage test leads or Clamp sensors while the instrument is off.
- Don't use the instrument at dusty places or to be spattered.
- Don't use the instrument under a strong electric storm or in the vicinity of energized object.
- Never give strong vibrations or drop shocks.
- While using a SD card, do not replace or remove the card. (  symbol blinks while accessing SD card.)

Otherwise, the saved data in the card may be lost or the instrument may be damaged.

**- Clamp sensor -**





- Do not bend or pull the cable of the Clamp sensor.

**- Treatment after use -**

- Power off the instrument and disconnect the Power cord, Voltage test leads and Clamp sensors from the instrument.
- Remove the batteries if the instrument is to be stored and will not be in use for a long period.
- Remove the SD card when carrying the instrument.
- Never give strong vibrations or drop shocks when carrying the instrument.
- Do not expose the instrument to direct sunlight, high temperatures, humidity or dew.
- Use a damp cloth with neutral detergent or water for cleaning the instrument. Do not use abrasives or solvents.
- Do not store the instrument if it is wet.

Carefully read and follow the instructions:  **DANGER**,  **WARNING**, **CAUTION** and **NOTE ( )** described in each section.

The following symbols are used in this manual:

	User must refer to the explanations in the instruction manual.
	Instrument with double or reinforced insulation
	AC
	(Functional) Earth terminal





# 1. Instrument Overview

## 1.1 Functional Overview

### SET UP

Make settings for KEW6305 or for measurements.

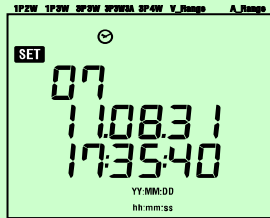

See “*Setting (Section 4)*” for further details.

### WIRING CHECK

Check the connections and display the results.



See “*Wiring check (Section 10)*” for further details.

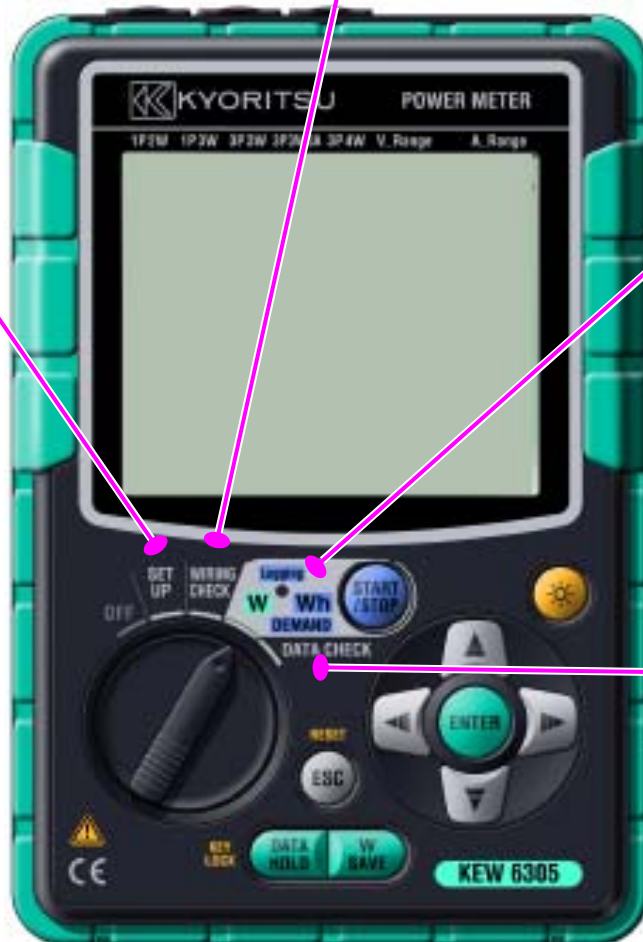

## **W** Instantaneous value measurement

Measure/ display the instantaneous values of current, voltage and electric power.

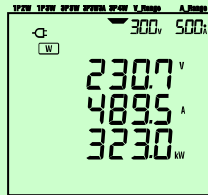

See “*Instantaneous value Measurement (Section 6)*” for further details.

## **Wh** Integration value measurement

Display/ record active/ apparent/ reactive energies, and record the average/ max/ min values of measured instantaneous values.

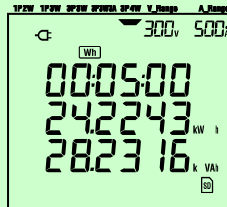

See “*Integration value Measurement (Section 7)*” for further details.

## **DEMAND** Demand measurement

Display/ record demand values based on the preset target values.

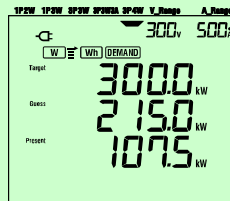

See “*Demand Measurement (Section 8)*” for further details.

## **DATA CHECK**

Recall and show the saved data on the LCD.

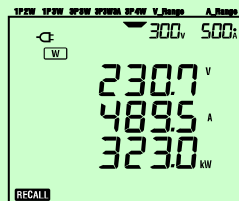

See “*Saved data (Section 10)*” for further details.

## 1.2 Features

This is a digital Power Clamp Meter that can be used for various wiring systems. Measured data can be saved either in the internal memory or SD card, and can be transmitted to PC via USB connection or by using SD card reader.

### Safety Construction

Designed to meet the international safety standard IEC 61010-1 CAT.III 600V.

### Wiring configuration

KEW6305 supports: Single-phase 2-wire, Single-phase 3-wire, Three-phase 3-wire, Three-phase 4-wire.

### Measurement and calculation

KEW6305 measures voltage (RMS), current (RMS), active power, frequency and calculates reactive/ apparent power, power factor, neutral current and active/ reactive/ apparent energy.

### Demand measurement

Electricity consumption can be easily monitored so as not to exceed the target maximum demand values.

### Saving data

KEW6305 is endowed with a logging function with a preset recording interval. Data can be saved by manual operation or at pre-set time & date.

### Dual power supply system

KEW6305 operates either with an AC power supply or with batteries. Both dry-cell batteries (alkaline) and rechargeable batteries (Ni-MH) can be used. In the event of an interruption, while operating with an AC power supply, power to the instrument is automatically restored by the batteries in the instrument.

### Large display

Up to 3 measured items can be displayed on the large screen simultaneously.

### Light & compact design

Clamp sensor type, compact and light weight design

### Application

Data in the internal memory and in SD card can be transmitted to PC using USB connection or SD slot. The supplied PC software application enables easy settings of the instrument and analysis of the saved data from PC.

## 1.3 Measuring Procedure

- Steps for measurement

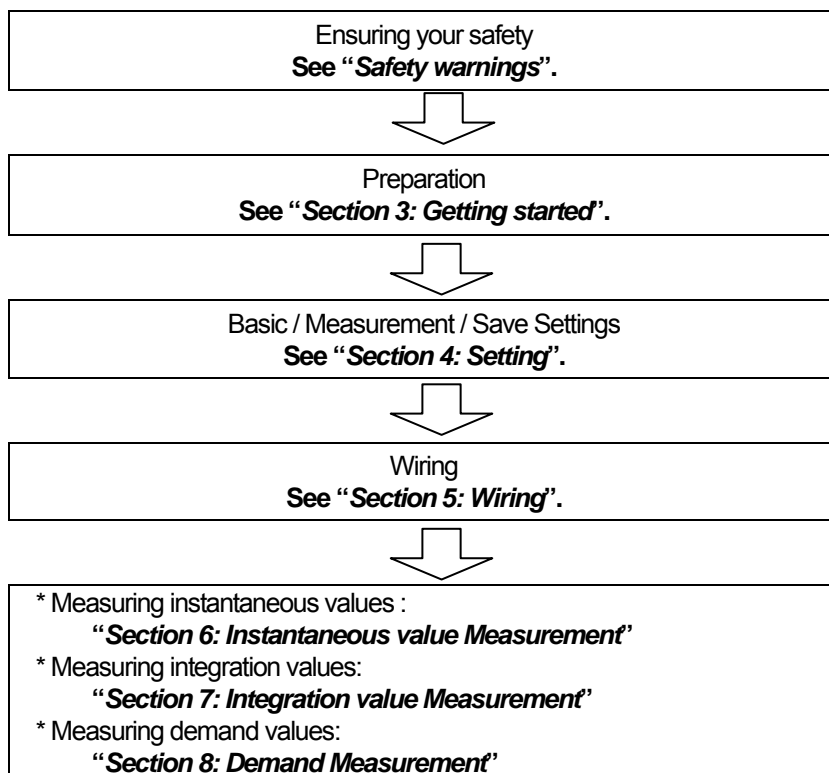

## 1.4 Outline of max demand measurement concept

In some countries, large consumers of electricity will usually have a maximum demand contract with the power company. Such contract varies from country to country. The following is an explanation of a typical Japanese maximum demand contract.

- Maximum Demand contract

In such a contract the electricity tariff rates (i.e. for kWhr units) are based upon the consumer's maximum power demand. The maximum demand is the maximum of average powers recorded over a 30min intervals.

This is measured by the maximum demand meter belonging to the power company. Let's assume that a power company has the following applicable rates.

\$2 per kWhr unit for a recorded max demand 300KW during a year

\$4 per kWhr unit for a recorded max demand 500KW during a year

\$5 per kWhr unit for a recorded max demand 600KW during a year

Assuming that the consumer is on the 500kW/year rate (ie. \$4), and the recorded max demand during a particular day(say 15th January) is 600kW . Then the new applicable rate from 1st February onwards will be the 600kW/year rate (ie. \$5) for the next 365 days. If a year later, on February 1st the recorded maximum demand is 300kW, then the new applicable rates will be changed to 300kW/year rate (i.e. \$2) for the subsequent 365 days. However if during this period, the max demand goes up again, and say 600kW is recorded on 15th March, the applicable rates change again to the 600kW/year rate (i.e.\$5) for the subsequent 365 days.

- Benefits of maximum demand control

It is thus important for consumers with such contracts to monitor closely fluctuations in their power demand to ensure that their max demand limits are not exceeded and thus incur higher tariffs. Maximum Demand control is more effective in countries with higher electricity tariffs.

- Status of maximum demand contract

In the past, in Japan, only consumers whose electricity supply was rated at 600kW or more used to enter into a demand contract. However, nowadays power companies install maximum demand meters at all consumers whose supply is rated 70kW or more.

- Maximum Demand measurement limitations

N.B. The readings from power company maximum demand meter and from the 6300 will not match completely due to an obvious time-lag difference in the start of the integration period (eg.30mins) over which the max demand is taken.



## 2. Instrument Layout

### 2.1 Front view

#### Display (LCD) / Keys

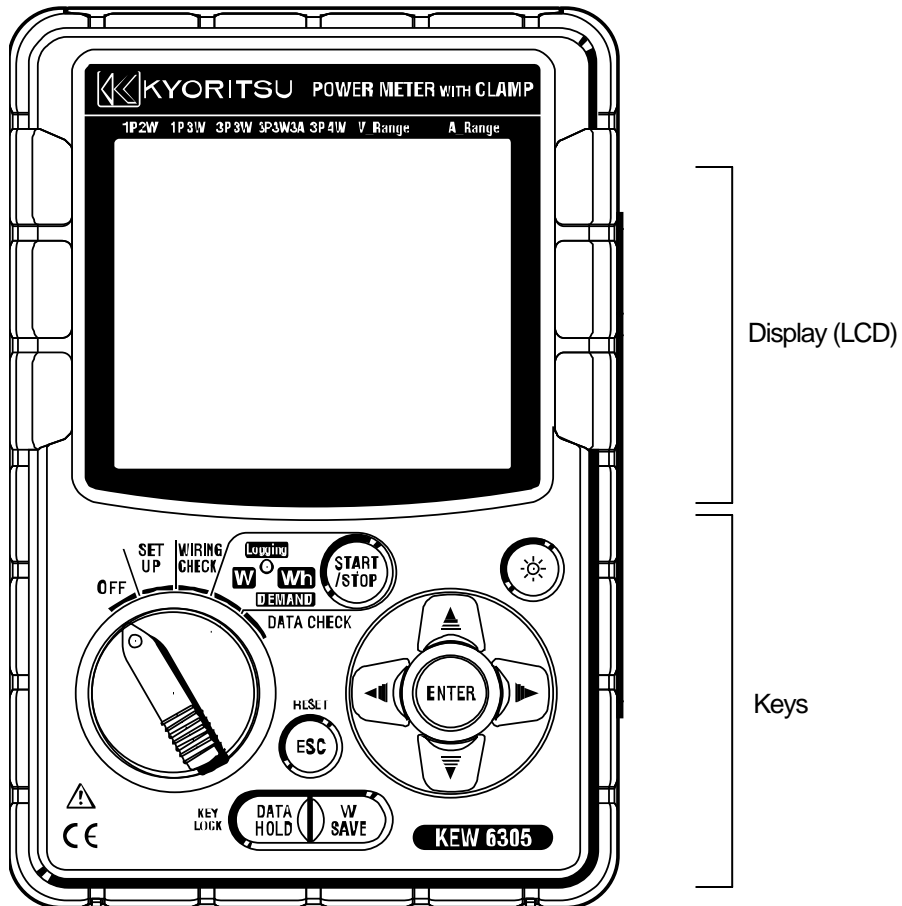

#### LED status indicator





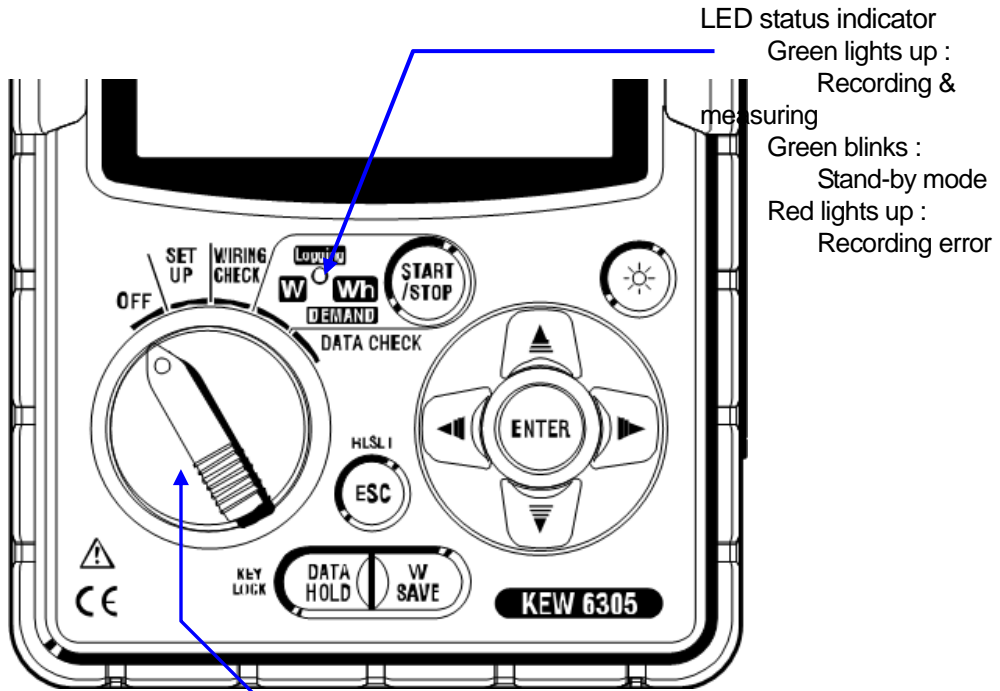

- Green lights up : Recording & measuring
- Green blinks : Stand-by mode (lights up when preset rec. start time comes)
- Red blinks : Charging batteries



## Key functions



Function switch:  
 Power on KEW6305. (Rotate to any position other than “OFF”.)







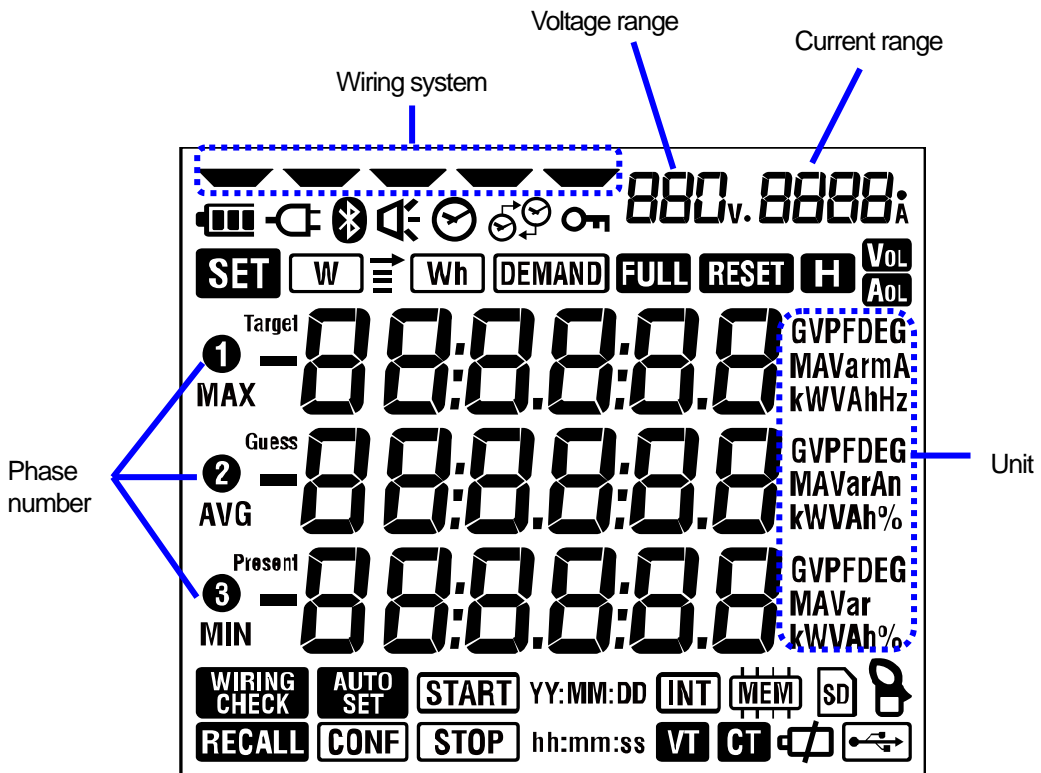











Keys		Details
	<b>START/STOP</b> Key	Start/ stop integration and demand measurement.
	<b>Backlight</b> Key	Turn on/ off the LCD backlight.
	<b>Cursor</b> Key	On measurement screen: switch screens, and on setting screen: select setting items or change values or digits
	<b>ENTER</b> Key	Confirm entries.
	<b>ESC</b> Key	* Cancel setting changes, * Clear integration / demand values.
	<b>DATA HOLD</b> Key	* Data hold * Key lock A long press (2 sec or longer) locks Keys and another long press (2 sec or longer) unlocks the locked Keys.
	<b>SAVE</b> Key	Save the measured instantaneous values.

## 2.2 LCD indications

< All symbols to be displayed on the LCD >



< Symbols indicate the functions or status during measurement >

Symbols	Functions and status during measurement
	Lights up when the keys are locked.
	Lights up when voltage exceeds a certain condition.
	Lights up when current exceeds a certain condition.
	Lights up when instruments is working by AC power supply.
	Lights up when instruments is working by batteries.
	Lights up when data hold function is activated.
	Lights up when selecting <b>SET UP</b> Range.
	Lights up when selecting <b>WIRING CHECK</b> Range.
	Blinks while instantaneous values are being displayed on the LCD.
	Blinks while integration values are being displayed on the LCD.
	Blinks while demand values are being displayed on the LCD.
	When the capacity of SD card or internal memory is exceeded.
	Lights up when selecting <b>DATA CHECK</b> Range.
	Lights up while data can be saved in the SD card, and blinks while saving data.
	Lights up while a USB cord is connected to the terminal, and blinks during data communication.
	Lights up while using Bluetooth communication.
	Lights up while data can be saved in the internal memory, and blinks while accessing to the memory.
	Lights up when VT ratio is set to other than "1".
	Lights up when CT ratio is set to other than "1".

## 2.3 Connector

### Descriptions

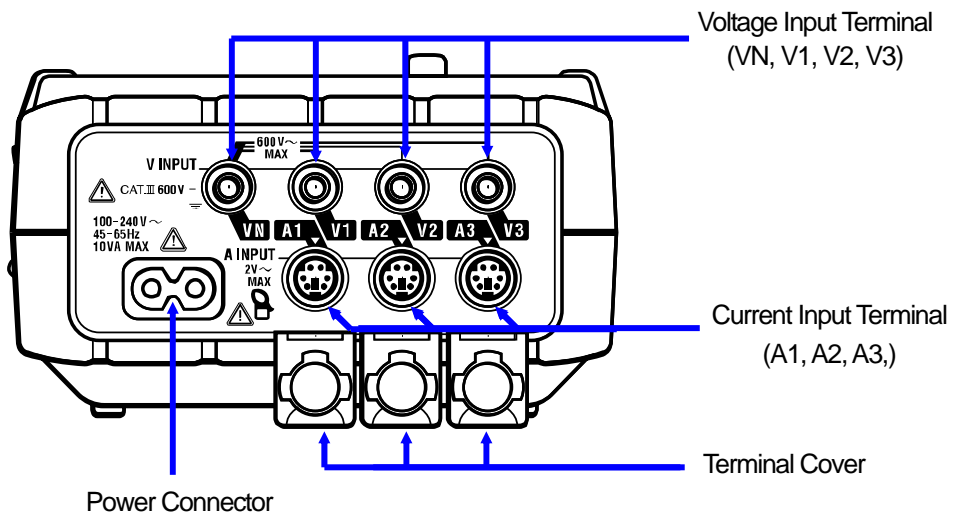

Wiring configuration		Voltage Input Terminal	Current Input Terminal
Single-phase 2-wire	1P2W(1ch)	VN, 1	A1
Single-phase 2-wire (2ch)	1P2W(2ch)	VN, 1	A1, 2
Single-phase 2-wire (3ch)	1P2W(3ch)	VN, 1	A1, 2, 3
Single-phase 3-wire	1P3W	VN, 1, 2	A1, 2
Three-phase 3-wire	3P3W	VN, 1, 2	A1, 2
Three-phase 3-wire 3A	3P3W3A	V1, 2, 3	A1, 2, 3
Three-phase 4-wire	3P4W	VN, 1, 2, 3	A1, 2, 3

## 2.4 Side face

### Descriptions

< When the Connector cover is closed. >

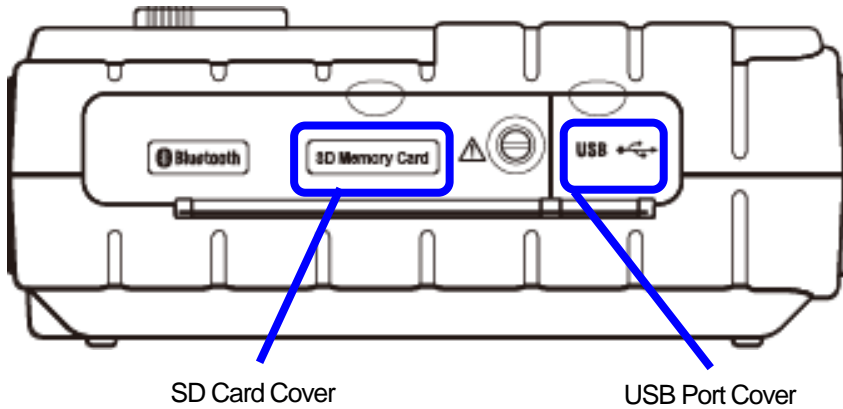

< When the Connector cover is opened. >

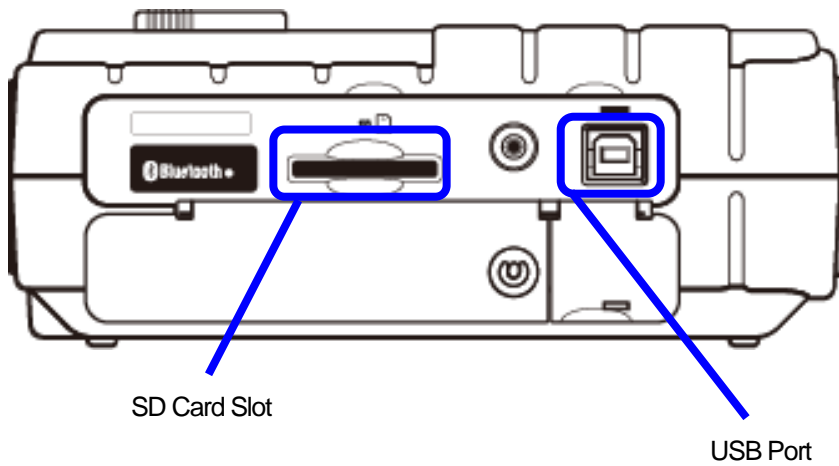

## 3. Getting started

### 3.1 Power Supply

#### 3.1.1 Battery

KEW6305 operates with either an AC power supply or batteries.

Capable of performing measurements in the event of AC power interruption, power to the instrument is automatically restored by the batteries installed in the instrument. Dry-cell batteries (alkaline) and rechargeable batteries (Ni-MH) can be both used.

\* Dry-cell batteries (alkaline) are supplied as accessories.

#### DANGER

- Never open the Battery Cover during a measurement.
- Brand and type of the batteries to be used should be harmonized.
- Never touch the Power supply connector although it is insulated while the instrument is operating with batteries.

#### WARNING

- Ensure that the Power cord, Voltage test leads and Clamp sensor are removed from the instrument, and that the instrument is switched off when opening the Battery cover for battery replacement.

#### CAUTION

- Never mix new and old batteries.
- Install batteries in correct polarity as marked inside the Battery compartment area.

Batteries are not in the instrument at the time of purchase. Please insert the supplied batteries before starting to use the instrument. Battery power is consumed even if the instrument is being off. Remove all the batteries if the instrument is to be stored and will not be in use for a long period.

When the instrument is powered by an AC power supply, it doesn't operate with batteries.

**If an AC supply is interrupted and the batteries have not been inserted, the instrument goes off and all data may be lost.**

## Power supply indicator

Symbol of power supply changes as follows.

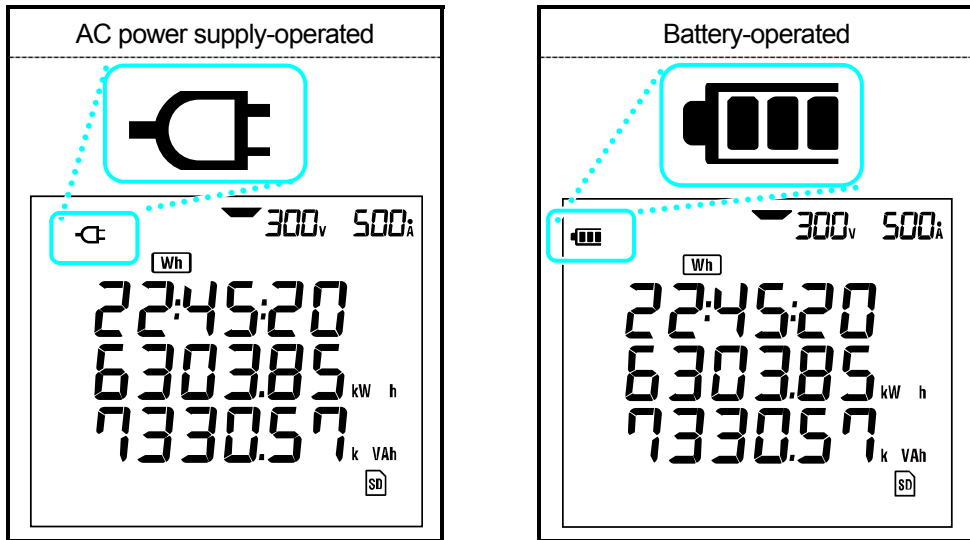

## Battery condition

Battery symbol varies as follows according to the battery condition.

	Battery operating time
	For approx. 15 hours, with new alkaline batteries.
	* It is reference time and will be shortened if using the backlight or Bluetooth function.
	Batteries are exhausted. (Accuracy of readings cannot be guaranteed.) Depending on the states of measurement, instrument operates as follows automatically. * while saving instantaneous value data (Files are opened.) -> Close the open files. (Data will be saved.) * while measuring integration/ demand values -> Force-quit measurements. (Data will be saved.)
(blink)	

## Inserting dry-cell batteries

- 1 Loosen two Battery Cover-fixing screws and remove the Cover.
- 2 Take out all the batteries.
- 3 Insert batteries (LR6 : size AA alkaline batteries) in correct polarity.
- 4 Install the Battery Cover and tighten two screws.
- 5 Connect the AC Power Cord and power on the instrument.

### 3.1.2 AC Power supply

! Check the followings before connecting the Power cord.

#### **! DANGER**

- Use only the Power cord supplied with this instrument.
- Connect the Power cord mains plug to a mains socket outlet. The mains supply voltage must not exceed AC240V. (max rated voltage of supplied Power cord MODEL7169 : AC125V)

#### **! WARNING**

- Confirm that the instrument is powered off, and then connect the Power cord.
- Connect the Power cord to the instrument first. Cord to be firmly inserted.
- Never attempt to make measurement if any abnormal conditions such as abnormal conditions are noted, such as a broken Cover and exposed metal parts.
- When the instrument is not in use, disconnect the Power cord from the outlet.
- When unplugging the cord from the mains socket outlet, do so by removing the plug first and not by pulling the cord.

### Power cord connection

Follow the procedure below, and connect the Power cord.

- 1 Confirm that the instrument is powered off.
- 2 Connect the Power cord to the Power connector on the instrument.

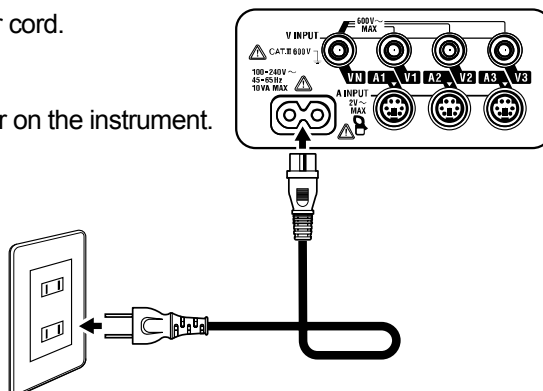

- 3 Connect the Power cord plug to the mains socket outlet.

### Power supply rating

Rating of power supply is as follows.

Rated supply voltage	:	100 to 240V AC ( $\pm 10\%$ )
Rated power supply frequency	:	45 to 65Hz
Max power consumption	:	10VA max



## 3.2 Voltage test leads and Clamp sensor connection

! Check the followings before connecting the test leads and sensors.

### DANGER

- Use only the Voltage test leads supplied with this instrument.
- Use the dedicated Clamp sensor for this instrument, and confirm that the measured current rating of the Clamp sensor is not exceeded.
- Do not connect all the Voltage test leads or Clamp sensors unless required for measuring the parameters desired.
- Connect the test leads and sensors to the instrument first, and only then connect them to the circuit under test.
- Never disconnect the Voltage test leads and sensors while the instrument is in use.

### WARNING

- Confirm that the instrument is powered off, and then connect the Power cord.
- Connect the Power cord to the instrument first. Cord to be firmly inserted.
- Never attempt to make measurement if any abnormal conditions such as abnormal conditions are noted, such as a broken Cover and exposed metal parts.

## Voltage test leads and Clamp sensor connection

Follow the procedure below, and connect the Voltage test leads and Clamp sensors.

- 1 Confirm that the instrument is powered off.
- 2 Connect the appropriate Voltage test leads to the Voltage input terminal on the instrument.
- 3 Connect the appropriate Clamp sensors to the Current input terminal on the instrument. Match the direction of the arrow mark indicated on the output terminal of the clamp sensor and the mark on the Current input terminal on the instrument.

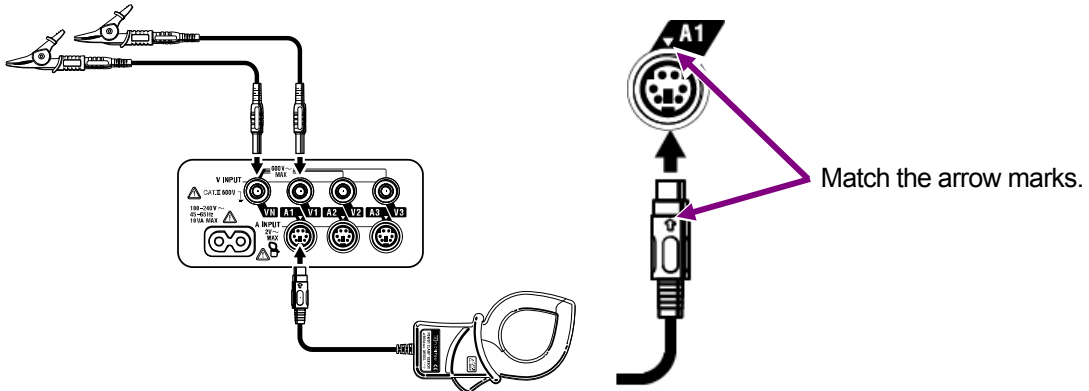

Number of Voltage test leads and Clamp sensors to be used will be different depending on the wiring configuration under test. For further details, refer to “**5.2 Basic Wiring Configuration**” in this manual.

### 3.3 Start KEW6305

#### 3.3.1 Start-up Screen

KEW6305 gets started when rotating and setting the Function switch to any position other than “OFF” position. Then, the Start-up screen will be displayed.

- 1 All the segments will be displayed for about 1 sec., and then MODEL/VERSION info will be displayed for about 1 sec..

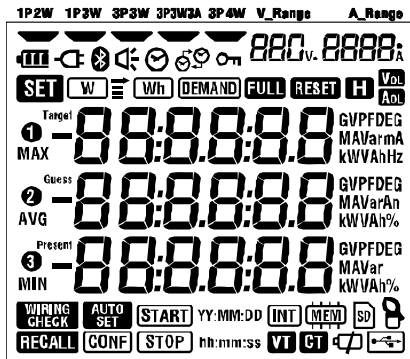

All segments to be displayed

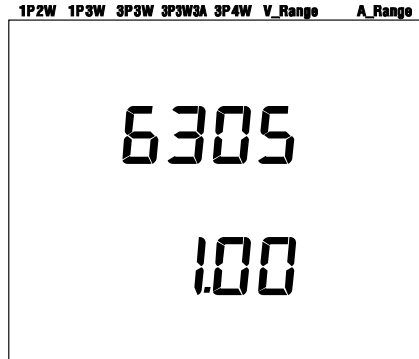

Model name/ Version info.

- 2 A screen corresponded to the selected range will be displayed.

### 3.3.2 Error message

This instrument automatically checks the internal circuit immediately after it is turned on.

When a failure in the internal circuit is suspected, the error screen below will be displayed for about 2 sec. prior to the start-up screen.

In case that following screen appears, stop using the instrument immediately and refer to “**Section 12: When defect or breakdown is suspected**” in this manual.

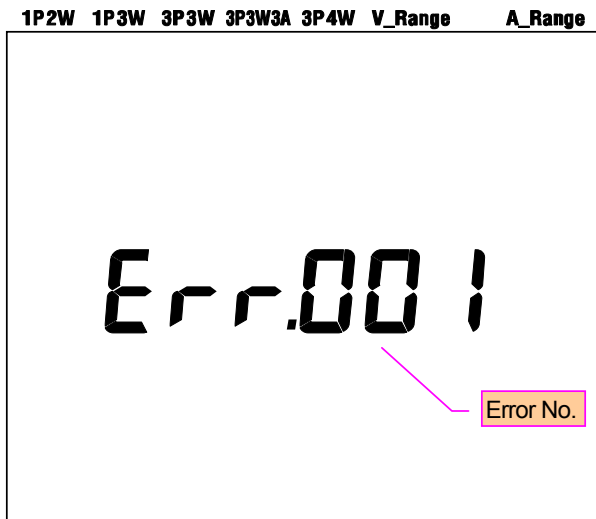

Error number (001 - 063)

Err.001  
{  
Err.063

#### CAUTION

Measurement can be done if the error screen appeared when powering on the instrument. However, the accuracy of the measured value may out of the specification.









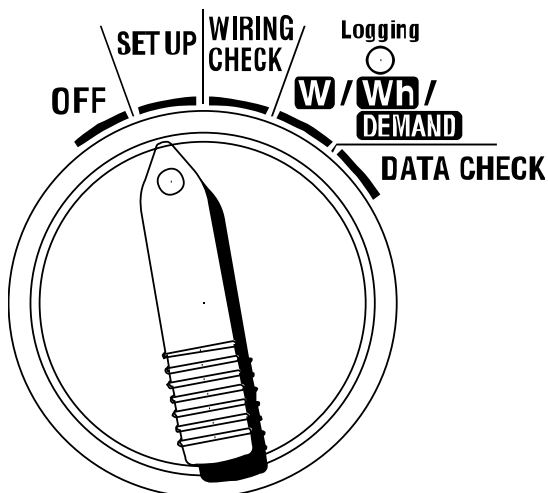

# 4. Setting

## 4.1 List of setting items

This section deals with settings for measurement and data saving.

Set the Function switch to **SET UP** range as follows.



Setting no./ item	Symbol	Details
01 Wiring system		1P2W(1ch)/ 1P2W(2ch)/ 1P2W(3ch) / 1P3W/ 3P3W/ 3P3W3A/ 3P4W
02 Voltage range		150/ 300/ 600V
03 Clamp sensor		50/ 100/ 200/ 500/ 1000/ 3000A type
04 Current range	-	03 Sensor Range
		50A 1/5/10/25/50A/AUTO
		100A 2/10/20/50/100A/AUTO
		200A 4/20/40/100/200A/AUTO
		500A 10/50/100/250/500A/AUTO
		1000A 20/100/200/500/1000A/AUTO 3000A 300/1000/3000A
05 VT ratio		0.01 - 9999.99 (can be set by 0.01)
06 CT ratio		0.01 - 9999.99 (can be set by 0.01)
07 Date and time		Year:Month:Day:Hour:Minute:Second
08 Buzzer		ON / OFF
09 Recording interval		1/ 2/ 5/ 10/ 15/ 20/ 30 sec./ 1/ 2/ 5/ 10/ 15/ 20/ 30 min./ 1 hour
10 Specific time period rec. or endless rec.		ON: Specifying start/ stop time (repeatedly recorded) OFF : Record the data continuously
11 <sup>*</sup> Time period setting Time setting		Start and stop time (Year:Month:Day:Hour:Minute:Second)

12 <sup>*1</sup>	Time period setting Date setting	 +   YY:MM:DD	Year:Month:Day:Hour:Minute:Second
13 <sup>*2</sup>	Start of continuous measurement	 +  YY:MM:DD	Year:Month:Day:Hour:Minute:Second
14 <sup>*2</sup>	End of continuous measurement	 +  YY:MM:DD	Year:Month:Day:Hour:Minute:Second
15	Target demand	+ Target	Value : 0.1 - 999.9 Unit: W/kW/MW/GW/VVA/kVA/MVA/GVA
16	Demand measure- ment cycle	+	NO/ 10/ 15/ 30 min * Demand measurement will not be performed when "NO" has been selected.
17	Demand warning cycle	+	1/2/5 min. when measurement cycle is 10or15 min., 1/2/5/10/15 min. when measurement cycle is 30 min.
18	Available space in SD card		Show the available space in the installed SD card in percentage.
19	SD card Format		ON(Format)/ OFF(Not format)
20	Available space in Internal memory		Show the available space in the internal memory in percentage.
21	Internal memory Format		ON(Format)/ OFF(Not format)
22	System reset		ON(Reset)/ OFF(Not reset)
23	ID number	-	Designate ID no. (00-001 - 99-999)
24	Setting read		Save no.: 01 - 20
25	Setting save		Save no.: 01 - 20
26	Bluetooth		ON/ OFF
27	V/A Range Auto-setting		ON/ OFF

\*1 : Setting 11& 12 can be changed only when Setting 10 has been set to "ON".

\*2 : Setting 13& 14 can be changed only when Setting 10 has been set to "OFF".

## 4.2 Setting procedure of each setting item

### “Setting 01” Wiring system

Following explains how to make settings for wiring system.

Select the appropriate wiring system according to the environment to be measured.

Setting item	1P2W(1ch)	: Single-phase 2-wire (1ch)
	1P2W(2ch)	: Single-phase 2-wire (2ch)
	1P2W(3ch)	: Single-phase 2-wire (3ch)
	1P3W	: Single-phase 3-wire
	3P3W	: Three-phase 3-wire
	3P3W3A	: Three-phase 3-wire
	3P4W	: Three-phase 4-wire
Default value (or after system reset)		3P3W

\* **Two-wattmeter method should be used for measuring 3P3W that requires using two Clamp sensors.**

\* **For measuring/ recording the voltage and current on each phase, select “3P3W3A” and use three Clamp sensors.**

- 1 Use the **Cursor** key on the selection screen, and select “Setting 01”.
- 2 Press the **ENTER** key to get the instrument into setting change mode.
- 3 Present setting (or default value: 3P3W) blinks. Select the appropriate wiring configuration with the **Cursor** key, and then press the **ENTER** key after making necessary change.

## “Setting 02” Voltage rang

Selecting a measurement range so that the estimated inputs will be close to the full scale value is recommended to obtain accurate results. Recommended range selections are: 150V range for rated voltages between 100 - 120V, 300V range for 200 - 240V and 600V range for 400 – 440V.

Setting item	150V / 300V / 600V
Default value (or after system reset)	300V

- 1 Use the **Cursor** key on the selection screen, and select “Setting 02”.
- 2 Press the **ENTER** key to get the instrument into setting change mode.
- 3 Present setting (or default value: 300V) blinks. Select the appropriate voltage range with the **Cursor** key, and then press the **ENTER** key after making necessary change.

## “Setting 03” Clamp sensor

Selectable Current range (“**Setting 04**”) differs by the selected Clamp sensors.

Clamp sensor	Current range (“ <b>Setting 04</b> ”)
50A (M-8128)	1 / 5 / 10 / 25 / 50A / AUTO
100A (M-8127)	2 / 10 / 20 / 50 / 100A / AUTO
200A (M-8126)	4 / 20 / 40 / 100 / 200A / AUTO
500A (M-8125)	10 / 50 / 100 / 250 / 500A / AUTO
1000A (M-8124)	20 / 100 / 200 / 500 / 1000A / AUTO
3000A	300 / 1000 / 3000A
Default value (or after system reset)	500A

- 1 Use the **Cursor** key on the selection screen, and select “Setting 03”.
- 2 Press the **ENTER** key to get the instrument into setting change mode.
- 3 Present setting (or default value: 500A) blinks. Select the appropriate clamp sensor with the **Cursor** key, and then press the **ENTER** key after making necessary change.

### NOTE:

- \* Accurate results may not be obtained if the Clamp sensors in use do not match the setting done for sensor.



## “Setting 04” Current range

Selectable Current range differs by clamp sensor selected at “Setting 03”.

Clamp sensor (“Setting 03”)	Current range
50A (M-8128)	1 / 5 / 10 / 25 / 50A / AUTO
100A (M-8127)	2 / 10 / 20 / 50 / 100A / AUTO
200A (M-8126)	4 / 20 / 40 / 100 / 200A / AUTO
500A (M-8125)	10 / 50 / 100 / 250 / 500A / AUTO
1000A (M-8124)	20 / 100 / 200 / 500 / 1000A / AUTO
3000A	300 / 1000 / 3000A
Default value (or after system reset)	AUTO

\* Selecting “AUTO” activates auto-ranging function and the measuring range will be automatically switched between the lowest and highest ranges.

- 1 Use the **Cursor** key on the selection screen, and select “Setting 04”.
- 2 Press the **ENTER** key to get the instrument into setting change mode.
- 3 Present setting (or default value: AUTO) blinks. Select the appropriate current range with the **Cursor** key, and then press the **ENTER** key after making necessary change.

### NOTE:

- \* When a type of clamp sensor (“Setting 04”) is changed, current range may be changed to the corresponding range automatically.
- \* Accurate results may not be obtained if the Clamp sensors in use do not match the setting done for sensor.
- \* Using the auto-ranging function can measure wide range of input signals, however, accurate results may not be obtained when measuring loads that fluctuate so widely within 1 sec..

## “Setting 05” VT ratio

For the detailed information about VT ratio, please refer to “5-3 VT/CT ratio” in this manual.

Setting range	0.01 - 9999.99 (can be set by 0.01)
Default value (or after system reset)	1.00

- 1 Use the **Cursor** key on the selection screen, and select “Setting 05”.
- 2 Press the **ENTER** key to get the instrument into setting change mode.
- 3 The rightmost digit of previous setting (or default value: 1.00) blinks. Change number with the **Cursor** key, and then press the **ENTER** key after making necessary change.

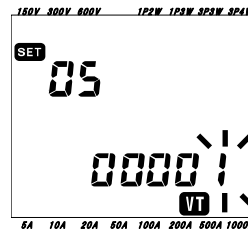

Function of **Cursor** keys:

	To select the digit subject to change.
	To change the value of selected digit.

When VT ratio is set to other than 1, “**VT**” mark appears on the LCD.

### NOTE

- \* When 0 is set as a VT ratio, it is forcefully changed to 1.

## “Setting 06” CT ratio

For the detailed information about CT ratio, please refer to “5-3 VT/CT ratio” in this manual.

Setting range	0.01 - 9999.99 (can be set by 0.01)
Default value (or after system reset)	1.00

- 1 Use the **Cursor** key on the selection screen, and select “Setting 06”.
- 2 Press the **ENTER** key to get the instrument into setting change mode.
- 3 The rightmost digit of previous setting (or default value: 1.00) blinks. Change number with the **Cursor** key, and then press the **ENTER** key after making necessary change.

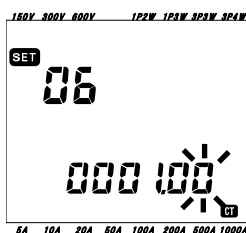

Function of **Cursor** keys:

	To select the digit subject to change.
	To change the value of selected digit.

When CT ratio is set to other than 1, “**CT**” mark appears on the LCD.

### NOTE

- \* When 0 is set as a CT ratio, it is forcefully changed to 1.

## “Setting 07” Time setting

- 1 Use the **Cursor** key on the selection screen, and select “Setting 07”.
- 2 Press the **ENTER** key to get the instrument into setting change mode.
- 3 Then second is forcefully changed to “00” and starts blinking. Select the time parameter to be changed with Left & Right **Cursor** key and change it with Up & Down **Cursor** Key.
- 4 Then press the **ENTER** key after making necessary change.

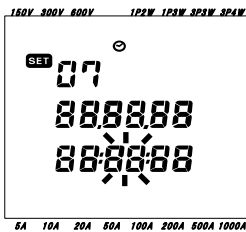

(\*) For the year, please set last 2 digits. (e.g. 2004 -> 04)

Time	Setting range
second	00 - 59
minute	00 - 59
hour	00 - 23
day	01 - 31
month	01 - 12
year	00 - 50*

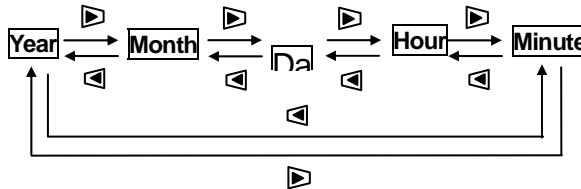
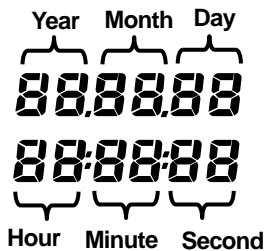

Function of **Cursor** keys:

	To select a time parameter subject to change.
	To change the value of selected time parameter.

## “Setting 08” Buzzer setting

- 1 Use the **Cursor** key on the selection screen, and select “Setting 08”.
- 2 Press the **ENTER** key to get the instrument into setting change mode.
- 3 Present setting (or default value: on) blinks. Press the **Cursor** key to select “on” (sound) or “oFF” (not sound), then press the **ENTER** key after making necessary change.

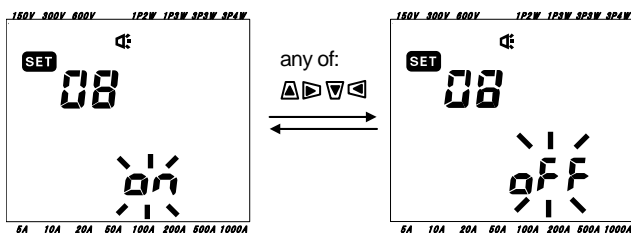

## “Setting 09” Recording interval

Following explains how to set the recording interval for integration/ demand measurement.

The recording interval is a time distance to record each measurement data into SD Card or internal memory.

Setting time	1/ 2/ 5/ 10/ 15/ 20/ 30 sec.,
	1/ 2/ 5/ 10/ 15/ 20/ 30 min.,
	1 hour
Default value (or after system reset)	30 min.

- 1 Use the **Cursor** key on the selection screen, and select “Setting 09”.
- 2 Press the **ENTER** key to get the instrument into setting change mode.
- 3 Previous setting (or default value: 30 min.) blinks. Press the **Cursor** key to select any desired time, and then press the **ENTER** key after making necessary change.

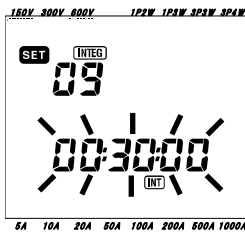

### NOTE:

- \* Selectable interval is limited by the setting done at Setting 16 (Demand measurement cycle).
- An interval greater than the value set at Setting 16 cannot be selected.
- The interval should be divisible by the value set at Setting 16.
- Any of above interval is selectable if “NO” is selected at Setting 16.

## “Setting 10” Specific time period rec. or endless rec.

- 1 Use the **Cursor** key on the selection screen, and select “Setting 10”.
- 2 Press the **ENTER** key to get the instrument into setting change mode.
- 3 Present setting (or default value: OFF) blinks. Press the **Cursor** key to select “ON” or “OFF”.
  - ON : Specify the recording start / stop time (repeatedly recorded).
  - OFF : Record the data continuously.
- 4 Press the **ENTER** key after making necessary change.

### NOTE:

- \* Setting screens for Setting 11 to 14 may not be displayed according to the setting done at Setting 10.
  - When Setting 10 has been set to “ON”, setting screens for Setting 11 and 12 will be displayed but for Setting 13 and 14 will not be displayed.
  - When Setting 10 has been set to “OFF”, setting screens for Setting 13 and 14 will be displayed but for Setting 11 and 12 will not be displayed.

## “Setting 11” Time period setting (Time setting)

Following explains how to set recording start / stop time.

- 1 Use the **Cursor** key on the selection screen, and select “Setting 11”.
- 2 Press the **ENTER** key to get the instrument into setting change mode.
- 3 Then second for recording stop time will blink.
- 4 Select the time parameter to be changed and change it with **Cursor** Key.
- 5 Then press the **ENTER** key after making necessary change.

\* Start time is displayed on the upper line and stop time is on the lower line.

### **NOTE:**

This setting item will not be displayed if Setting 10 has been set to “OFF”.



## “Setting 12” Time period setting (Date setting)

Following explains how to set recording start / stop date.

- 1 Use the **Cursor** key on the selection screen, and select “Setting 12”.
- 2 Press the **ENTER** key to get the instrument into setting change mode.
- 3 Then day for recording stop date will blink.
- 4 Press the **Cursor** Key and select any desired date.
- 5 Then press the **ENTER** key after making necessary change.

\* Start date is displayed on the upper line and stop date is on the lower line.

### Example:

When recording start / stop time and date have been set as follows,

Setting 11 (time) = 8:00:00 - 18:00:00

Setting 12 (date) = 12.08.01 - 12.08.07

the instrument automatically performs recording at the following time and date.

1. 8:00 to 18:00 on August 1, 2012,
2. 8:00 to 18:00 on August 2, 2012,
3. 8:00 to 18:00 on August 3, 2012,
4. 8:00 to 18:00 on August 4, 2012,
5. 8:00 to 18:00 on August 5, 2012,
6. 8:00 to 18:00 on August 6, 2012 and
7. 8:00 to 18:00 on August 7, 2012.

### NOTE:

This setting item will not be displayed if Setting 10 has been set to “OFF”.

## “Setting 13” Start of continuous measurement

- 1 Use the **Cursor** key on the selection screen, and select “Setting 13”.
- 2 Press the **ENTER** key to get the instrument into setting change mode. On the LCD, time (Setting. 07);1 min. put forward on, is displayed and second will blink.
- 3 Change the time and date with **Cursor** Key.
- 4 Then press the **ENTER** key after making necessary change.

Year Month Day  
 04.04.07  
 10:30:00  
 Hour Minute Second

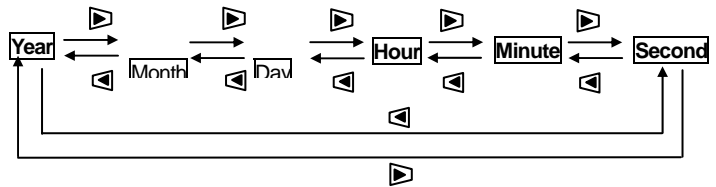

Function of **Cursor** keys:

	To select a time parameter subject to change.
	To change the value of selected time parameter.

## “Setting 14” Stop of continuous measurement

- 1 Use the **Cursor** key on the selection screen, and select “Setting 14”.
- 2 Press the **ENTER** key to get the instrument into setting change mode. On the LCD, measurement start time (Setting 13) + 1 hour, is displayed and second will blink.
- 3 Change the time and date with **Cursor** Key.
- 4 Then press the **ENTER** key after making necessary change.

### Example:

When start / stop time and date have been set as follows,

Setting 13 (start) = 12.08.01, 08:00:00

Setting 14 (stop) = 12.08.07, 18:00:00

the instrument automatically performs measurement during the following period.

From 8:00 on August 1, 2012 to 18:00 on August 7, 2012

### NOTE:

- \* The stop time and date (Setting 14) should be set after the start time (Setting 13) in such a way to give enough time to the user to complete all settings before the measurement starts.

Otherwise, an error message will be displayed on the LCD and the instrument cannot start measurement and data recording.

When an error message appears, press the **ENTER** key and rotate the Function switch to the SETUP range to redo settings.



## “Setting 15” Target demand

For details about demand target value, please refer to “**Section 8**”: *Demand measurement*. Target value can be selected between 0.1W and 999.9GW.

	Value	Unit
Demand target value	0.1 - 999.9 (can be set by 0.1)	W / kW / MW / GW VA / k VA / M VA / G VA
Default value (or after system reset)	100.0kW	

- 1 Use the **Cursor** key on the selection screen, and select “Setting 15”.
- 2 Press the **ENTER** key to get the instrument into setting change mode.
- 3 Present setting (or default value: 100.0kW) blinks. Change the value and unit with the **Cursor** key.
- 4 Press the **ENTER** key after making necessary change.

Function of **Cursor** keys:

	To select the digit or unit parameter subject to change.
	To change the value of selected digit and unit parameter.

Either “W” or “VA” can be set as a unit.

The instrument can display and record the demand values of active and apparent power by switching above unit.

### NOTE:

- \* When the target value is set to 0.0, it is forcefully changed into 100.0.

## “Setting 16” Demand measurement cycle

Demand measurement cycle is to be used for calculating demand values.

Setting time	NO / 10 / 15 / 30 min
Default value (or after system reset)	30 min

\* Demand measurement will not be performed when “NO” has been selected.

- 1 Use the **Cursor** key on the selection screen, and select “Setting 16”.
- 2 Press the **ENTER** key to get the instrument into setting change mode.
- 3 Present setting (or default value: 30 min.) blinks. Press the **Cursor** key and set any desired time.
- 4 Press the **ENTER** key after making necessary change.

## “Setting 17” Demand warning cycle

The buzzer will sound when a predicted demand value exceeds a target demand value during demand measurement.

For further details, please refer to “**Section 8**”: *Demand measurement*.

According to the demand measurement interval, which has been set at Setting 16, warning cycle can be set to as follows.

Demand measurement cycle “Setting 16”	Warning cycle
10 / 15 min.	1 / 2 / 5 min.
30 min.	1 / 2 / 5 / 10 / 15 min.
Default value (or after system reset)	10 min.

- 1 Use the **Cursor** key on the selection screen, and select “Setting 17”.
- 2 Press the **ENTER** key to get the instrument into setting change mode.
- 3 Previous setting (or default value: 10 min.) blinks. Press the **Cursor** key to select any desired time, and then press the **ENTER** key after making necessary change.

## “Setting 18” Available space in SD card

Following explains how to check the available space in SD card.

- 1 Use the **Cursor** key on the selection screen, and select “Setting 18”.
- 2 Then the available space in the SD card in KEW6305 will be displayed. (0 – 100%, displayed by 1%)

\* Bars (“—”) will be displayed if SD card is not inserted.

### **NOTE:**

When using a 2GB SD card, 511 files (max) can be saved in. KEW6305 cannot perform any recording if the number of saved file exceeds the limit although there is available space in the SD card.

## “Setting 19” SD card Format

Newly purchased SD Card must be formatted before use.

For details about SD Card, please refer to “**Section 9: SD Card / Internal memory**” in this manual.

### CAUTION

Ensure that the Function switch is set to “OFF” position before placing / removing an SD Card. If an SD Card is placed / removed while the instrument is on, stored data or instrument may be damaged.

- 1 Confirm the Function switch is at “OFF” position, and then place an SD Card into the SD Card slot of the instrument.
- 2 Set the Function switch to **SET UP** range.
- 3 On the selection screen, select “Setting 19” with **Cursor** key.
- 4 Then press the **ENTER** key to get the instrument in setting change mode.
- 5 The message “OFF”(not format) will blink. Change it to “ON”(format) with **Cursor** key.  
(In case that no CF card is placed in the instrument, you cannot set it to “ON”.)
- 6 When pressing the **ENTER** key, format will start.  
(Formatting takes a few seconds.)
- 7 After formatting, a message “FINISH” is displayed on the LCD.

### NOTE:

- \* Please use SD card supplied with this instrument or supplied as optional parts.
- \* All the data in an SD card will be deleted after formatting.
- \* Be sure to check that SD Card works properly on the well-known hardware.
- \* As to the manipulation of SD Card, please refer to the instruction manual attached to the card.
- \* SD cards of 2GB capacity or less will be formatted to FAT16 and the cards of 4GB or more to FAT32.



## “Setting 20” Available space in Internal memory

Following explains how to check the available space in the internal memory.

- 1 Use the **Cursor** key on the selection screen, and select “Setting 20”.
- 2 Then the available space in the internal memory of KEW6305 will be displayed. (0 – 100%, displayed by 25%)

**NOTE:**

The max number of files that can be saved in the internal memory is four. If any of file size exceeds 2.25MB, no more file can be saved in the memory.

## “Setting 21” Internal memory Format

- 1 Use the **Cursor** key on the selection screen, and select “Setting 21”.
- 2 Then press the **ENTER** key to get the instrument in setting change mode.
- 3 The message “OFF”(not format) will blink. Change it to “ON”(format) with **Cursor** key.
- 4 When pressing the **ENTER** key, format will start.  
(Formatting takes a few seconds.)
- 5 After formatting, a message “FINISH” is displayed on the LCD.

### NOTE:

\* All the data in the internal memory will be deleted after formatting.

## “Setting 22” System reset

Following explains how to perform system reset to restore all the settings to the default. For further details about system reset, please refer to “**Section 11: Additional functions**” in this manual.

- 1 Use the **Cursor** key on the selection screen, and select “Setting 22”.
- 2 Then press the **ENTER** key to get the instrument in setting change mode.
- 3 The message “OFF”(not reset) will blink. Change it to “ON”(reset) with **Cursor** key.
- 4 When pressing the **ENTER** key, system reset will start.



\* The setting will return to “OFF” when system reset is done.

## “Setting 23” ID number

Setting range	00-001 - 99-999
Default value (or after system reset)	00 - 001

- 1 Use the **Cursor** key on the selection screen, and select “Setting 23”.
- 2 Press the **ENTER** key to get the instrument into setting change mode.
- 3 The rightmost digit of present setting (or default value: 1.00) blinks. Change number with the **Cursor** key, and then press the **ENTER** key after making necessary change.

Function of **Cursor** keys:

	To select the digit subject to change.
	To change the value of selected digit.

Any desirable number, aside from the serial number, can be assigned as an ID number and will be saved together with the recorded data file.

## “Setting 24” Setting read

Following explains how to load the settings saved at “Setting 25”. Please refer to “Setting 25” in which shows how to save the setting.

- 1 Use the **Cursor** key on the selection screen, and select “Setting 24”.
- 2 Press the **ENTER** key to get the instrument into setting change mode.
- 3 Chose the Setting save number from 01 to 20 with the **Cursor** key, and then press the **ENTER** key after making necessary change.

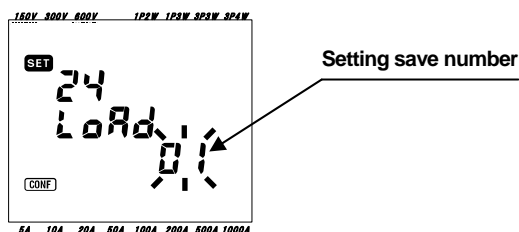

### NOTE

- \* When loading the Setting save number on which no setting has not been made, default setting at each setting (7 items) becomes effective.

## “Setting 25” Setting save

Following explains how to save the settings items.

Seven items below can be saved.

Making necessary settings on following 7 items, and saving them. Then it can be loaded from Setting 24 from the next time. Selectable number: 01 - 20

Setting no.	
Setting 01	Wiring system
Setting 02	Voltage range
Setting 03	Clamp sensor
Setting 04	Current range
Setting 05	VT ratio
Setting 06	CT ratio
Setting 08	Buzzer

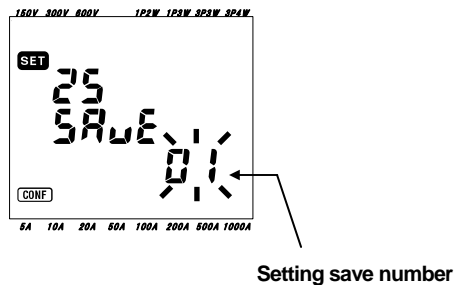

- 1 Above 7 items are set when needed. (Please refer to each setting procedure.)
- 2 Select Setting 25 with the **Cursor** key on the selection screen.
- 3 Press the **ENTER** key to get the instrument into setting change mode.
- 4 Select the Setting save number (01 - 20) with the **Cursor** key.
- 5 Press **ENTER** key after making necessary settings.

### NOTE:

- \* When new settings are made on the setting save number, on which settings already have done, the previous setting will be overwritten.
- \* All the saved items (settings) will restore to default after system-reset.

## “Setting 26” Bluetooth

- 1 Use the **Cursor** key on the selection screen, and select “Setting 26”.
- 2 Press the **ENTER** key to get the instrument into setting change mode.
- 3 Present setting (or default value: OFF) blinks. Press the **Cursor** key to select “ON” or “OFF”, and then press the **ENTER** key after making necessary change.

### NOTE:

- To conserve battery life, it is recommended to turn off the Bluetooth function when you are not using it.
- The LED (blue) lights up when “ON” is selected.

## “Setting 27” V / A range Auto-setting

Following explains how to activate auto-setting for Voltage range (Setting 02), Clamp meter (Setting 03), Current range (Setting 04).

- 1 Select the appropriate wiring configuration at Setting 01.
- 2 Connect the instrument to the circuit under test.
- 3 Use the **Cursor** key on the selection screen, and select “Setting 27”.
- 4 Press the **ENTER** key to get the instrument into setting change mode.
- 5 Press the **Cursor** key to select “ON”, and then press the **ENTER** key.

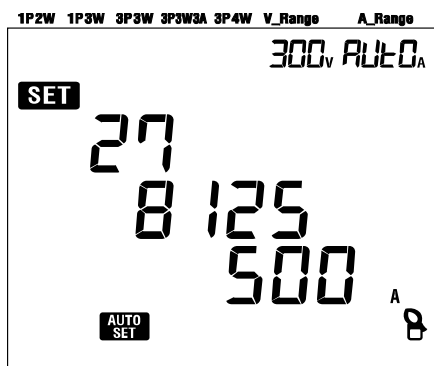

When a message “Err” appears on the LCD, please check the connections of Clamp sensors.

### NOTE:

- \* If the instrument fails to detect the connected sensor properly, the default setting (8125 / 500A Type) will become effective.
- \* For Current range, “AUTO” will be automatically selected.





## 5. Wiring configurations

### 5.1 Important Preliminary checks

#### **DANGER**

- Do not make measurements on a circuit in which the electrical potential exceeds AC600V.
- Connect the Power cord to a socket outlet. Never connect it to the socket outlet of AC240V or more.
- The Clamp sensor, Voltage test leads and Power cord are to be connected to the instrument first.
- The Voltage test leads or Clamp sensors should not be connected to the input terminals of the instrument if not required for measurement.
- The instrument should always be connected on the downstream side of a circuit breaker, which is safer than the upstream side.
- Do not open-circuit the secondary side of a supplementary CT while it is energized because of the high voltage generated at the secondary side terminals.
- Be careful to avoid short-circuiting the power line with the un-insulated part of the voltage test probes during the setting up of the instrument. Transformer jaw tips are designed in such a way to avoid short-circuiting. If the circuit under test has exposed conductive parts, extra care should be taken to minimize the possibility of shorting.

#### **WARNING**

- To avoid possible electric shock and short-circuit, always turn off the line under test when setting up the instrument.
- Do not touch the un-insulated tip of Voltage test probes. The use of safety insulated gloves is recommended.

- Clamp sensor direction for correct measurement:  
Ensure that the arrow mark on the clamp sensor points towards to load side.

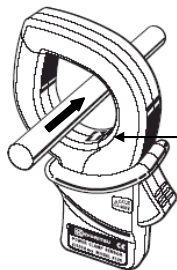

Arrow mark: Points towards load side.

## 5.2 Basic wiring configurations

### • Wiring method for single-phase 2-wire (1ch) "1P2W (1ch)"

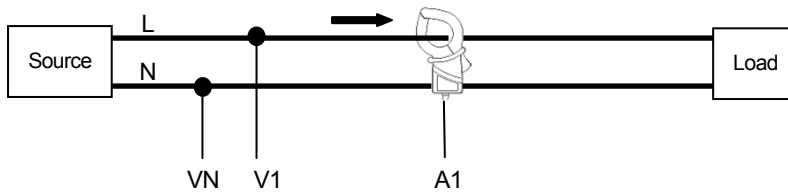

### • Wiring method for single-phase 2-wire (2ch) "1P2W (2ch)"

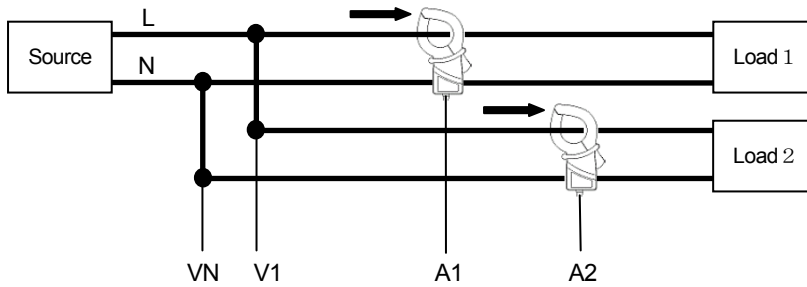

### • Wiring method for single-phase 2-wire (3ch) "1P2W (3ch)"

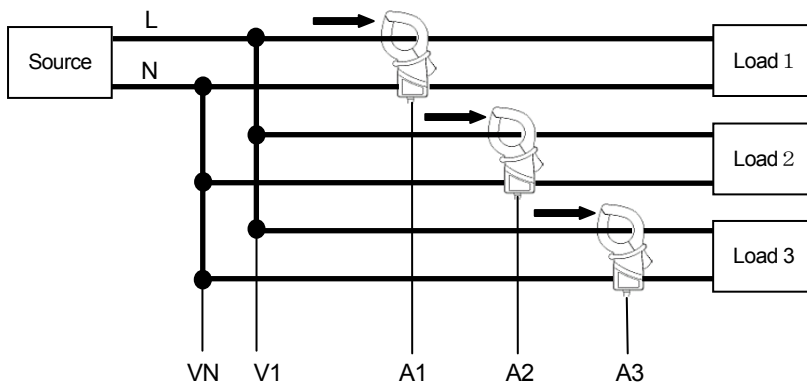

• Wiring method for single-phase 3-wire "1P3W"

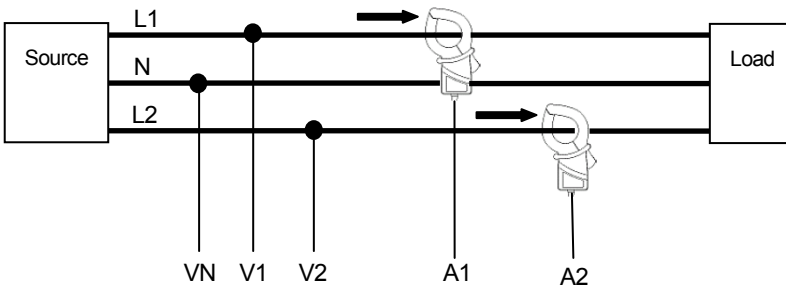

• Wiring method for three-phase 3-wire "3P3W"

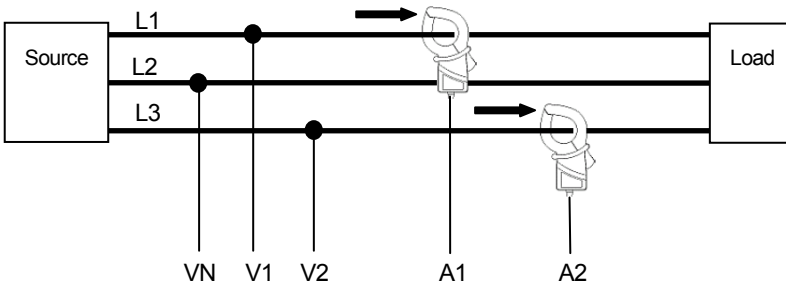

• Wiring method for three-phase 3-wire "3P3W3A"

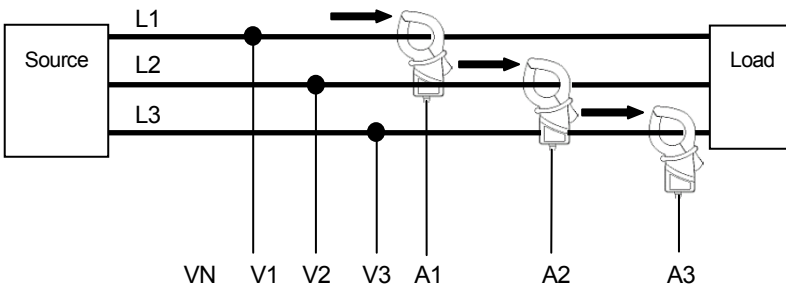

• Wiring method for three-phase 4-wire "3P4W"

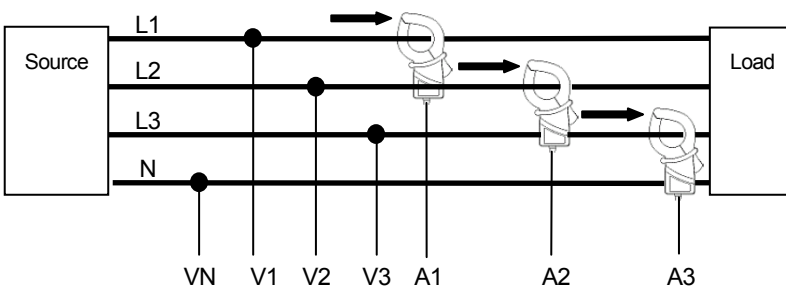

## 5.3 Using supplementary VT/ CT's (not supplied with the instrument)

### **⚠ DANGER**

- Never make measurement on a circuit in which electrical potential exceeds AC600V.
- Connect the Power cord to a socket outlet. Never connect it to the socket outlet of AC240V or more.
- This instrument must be used on the secondary side of VT(transformer) and CT(current transformer).
- Do not open-circuit the secondary side of a supplementary CT while it is energized because of the high voltage generated at the secondary side terminals.

### **⚠ CAUTION**

- When a VT or CT is used the measurement accuracy is not guaranteed due to several factors namely phase characteristics and VT/CT accuracies.

The use of supplementary VT/CT's may be required if the voltage/current values of the circuit under test fall outside the instrument measuring range. In this case the value at the primary side of circuit can be obtained directly by measuring the secondary side with appropriate an VT or CT installed in the line under test as follows.

#### <Example of single-phase 2-wire (1ch) "1P2W(1ch)">

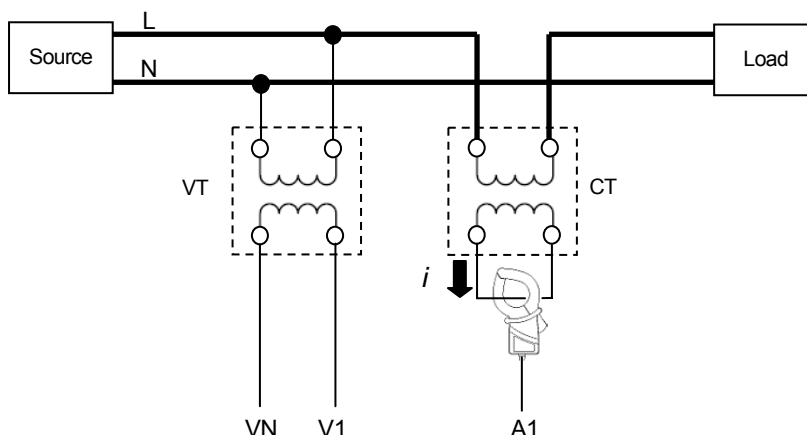

In this case, set the actual ratio of VT and CT to be used.

\* VT ratio: **"Setting 05"**

\* CT ratio: **"Setting 06"**

## 5.4 Wiring check

This instrument has Wiring check function to check the connections in order to prevent incorrect connections.

### 5.4.1 Check procedure

- 1 Rotate the Function switch to "WIRING CHECK" position. (Ensure that necessary Voltage test leads/ Clamp sensors are connected to the instrument/ circuit under test.)

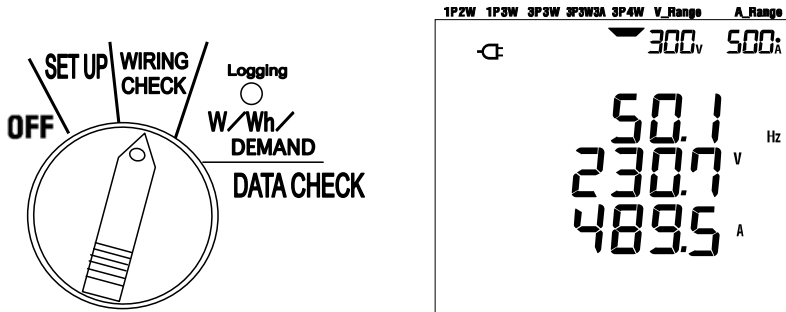

- 2 Press the ENTER Key. (Check will start.)

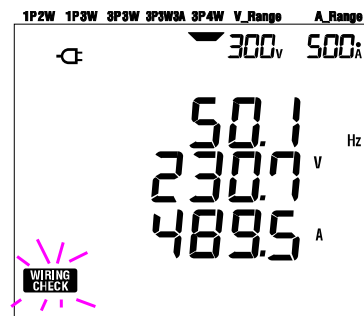

- 3 Check result will be displayed about 5 sec. later.

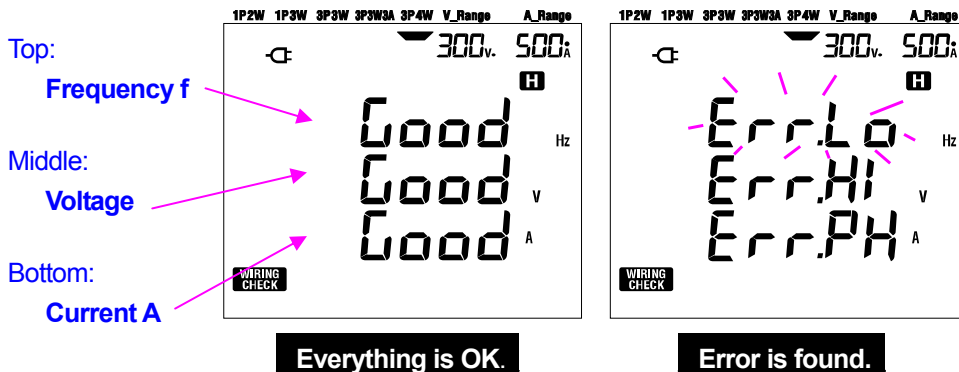

Move the cursor on the line showing an error, and press the **ENTER** Key. Then the suspected error value will be displayed on the LCD.

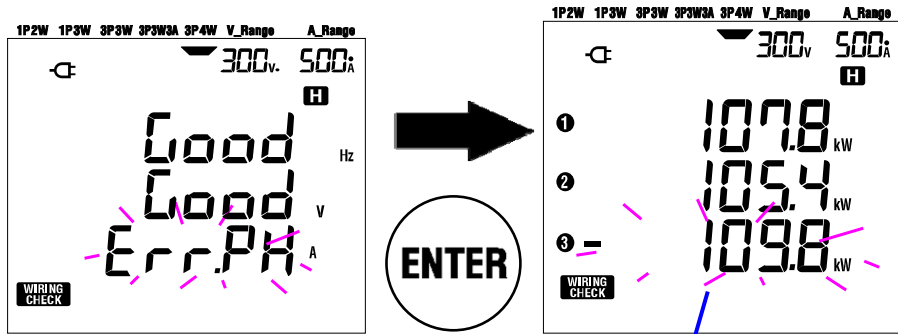

In this case, orientation of sensor (A3) may be incorrect.

## 5.4.2 Displayed contents

Selectable display screens at WIRING CHECK range are as follows.

Press the **Cursor** keys to switch following screens.

Wiring system (Setting 01)	Displayed at	Parameters to be displayed					
		Screen 1	Screen 2	Screen 3	Screen 4	Screen 5	Screen 6
3P4W 3P3W3A	Top	f	V1	A1	P1	PF1	DEG (V1)
	Middle	V (avg)	V2	A2	P2	PF2	DEG (V2)
	Bottom	A (avg)	V3	A3	P3	PF3	DEG (V3)
3P3W 1P3W	Top	f	V1	A1	P1	PF1	DEG (V1)
	Middle	V (avg)	V2	A2	P2	PF2	DEG (V2)
	Bottom	A (avg)	—	—	—	—	—
1P2W (3ch)	Top	f	V1	A1	P1	PF1	—
	Middle	V1	—	A2	P2	PF2	—
	Bottom	A (avg)	—	A3	P3	PF3	—
1P2W (2ch)	Top	f	V1	A1	P1	PF1	—
	Middle	V1	—	A2	P2	PF2	—
	Bottom	A (avg)	—	—	—	—	—
1P2W (1ch)	Top	f	V1	A1	P1	PF1	—
	Middle	V1	—	—	—	—	—
	Bottom	A1	—	—	—	—	—

### 5.4.3 Criteria of judgment

Check item	Criteria of Judgment	System to be checked						Error message
		3P4W	3P3W3A	3P3W	1P3W	1P2W-3	1P2W-2	
Frequency	Should be 45Hz or more.	f						Err.Lo_Hz
	Should be 65Hz or less.							Err.Hi_Hz
Voltage input	Should be 60% or more of (V range x VT ratio).	V1/V2/ V3	V1/ V2	V1			Err.Lo_V	
	Should be 110% or less of (V range x VT ratio).						Err.Hi_V	
Voltage balance	Should be within $\pm 10^\circ$ of reference phase.	DEG(V2) :120° DEG(V3) :240°	DEG (V2) :300°	DEG (V2) :180°	----		Err.PH_V	
Voltage phase	Should within $\pm 20\%$ against V1.	V2/V3	V2	----			Err.bL_V	
Current input	Should be 10% or more of (A range x CT ratio). <b>* One range low if auto-ranging has been selected.</b>	A1/A2/ A3	A1/A2	A1 / A2 / A3	A1 / A2	A1	Err.Lo_A	
	Should be 110% or less of (A range x CT ratio). <b>* One range high if auto-ranging has been selected.</b>						Err.Hi_A	
Current phase	PFi (absolute value) should be 0.5 or more. <b>* for 3P3W3A, <math>0 \leq PFi</math></b>	PF1/ PF2/ PF3	PF1/ PF2	PF 1 / PF 2 / PF 3	PF 1 / PF 2	PF 1	Err.PH_A	
	Pi should be positive value.	P1/P2/ P3	P1/P2	P1 / P2 / P3	P1 / P2	P1	Err.PH_A	

**\*KEW6305 may show any incorrect connection is found if great power factors (0.5 or less) exist at the measurement site.**



#### 5.4.4 Possible causes of errors

Check	Possible cause
Frequency	<ul style="list-style-type: none"><li>- Voltage clip is firmly connected to the DUT?</li><li>- Measuring too high harmonic components?</li></ul>
Voltage input	<ul style="list-style-type: none"><li>- Voltage clip is firmly connected to the DUT?</li><li>- Voltage test leads are firmly connected to the Voltage input terminal on the instrument?</li></ul>
Voltage balance	<ul style="list-style-type: none"><li>- Settings are matched with the wiring system under test?</li><li>- Voltage clip is firmly connected to the DUT?</li><li>- Voltage test leads are firmly connected to the Voltage input terminals on the instrument?</li></ul>
Voltage phase	<ul style="list-style-type: none"><li>- Voltage test leads are properly connected? (Connected to proper channels?)</li></ul>
Current input	<ul style="list-style-type: none"><li>- Clamp sensors are firmly connected to the Power input terminals on the instrument?</li><li>- Setting for Current Range is appropriate for input levels?</li></ul>
Current phase	<ul style="list-style-type: none"><li>- Arrow mark on the Clamp sensor and the orientation of flowing current coincide with each other? (Power supply to Load)</li><li>- Clamp sensors are connected properly?</li></ul>

## 6. Instantaneous value measurement

Set the Function switch to **W** range.

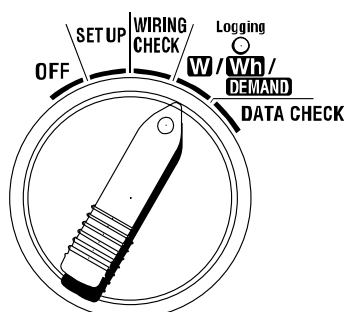

### • Indications

Measurement/Calculation parameter		Unit
Voltage (RMS)	$V_i$ : Voltage per phase(V1,V2,V3)	V
Current (RMS)	$A_i$ : Current per phase(A1,A2,A3)	A
Active power	$P$ : Total active power $P_i$ : Active power per phase Polarity: (no mark) consumption, - (minus) regenerating	W
Reactive power	$Q$ : Total reactive power $Q_i$ : Reactive power per phase Polarity: (no mark) phase lag, - (minus) phase lead	Var
Apparent power	$S$ : Total apparent power $S_i$ : Apparent power per phase	VA
Power factor ( $\cos \phi$ )	PF : Power factor of whole system $Pf_i$ : Power factor per phase Polarity:(no mark) phase lag, - (minus) phase lead	PF
Frequency	$f$ : Frequency of V1	Hz
Neutral current	$I_n$ : neutral current (only at three-phase 4-wire) $i = 1, 2, 3$	An

Displayed parameters can be changed according to needs.  
Refer to “6-3 Customizing display” in this manual.

### NOTE

- \* Above parameters vary depending on each wiring configuration.
- \* If V1 is out of measuring range, other parameters may not be measured or calculated.
- \* The chosen units for the power factor and neutral current are arbitrary.



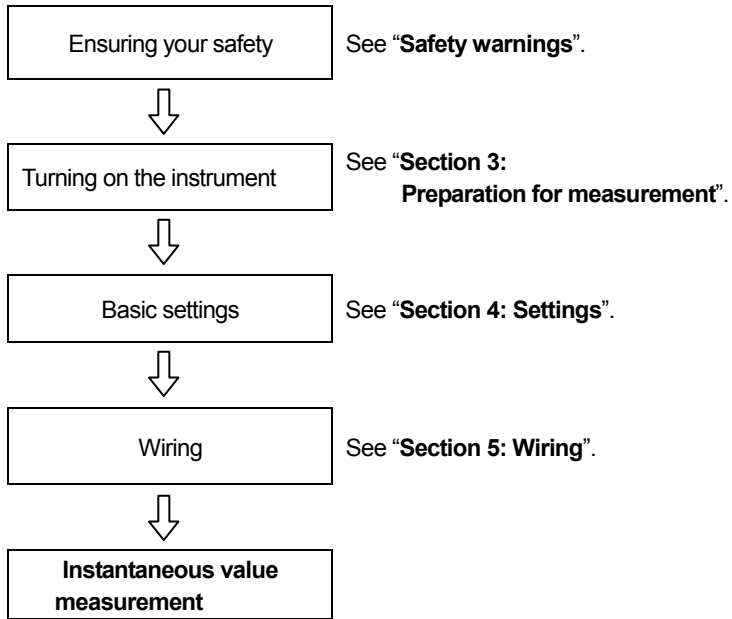





• **Prior to making a measurement**



• **Basic settings**

- “**Setting 01**” Wiring
- “**Setting 02**” Voltage range
- “**Setting 03**” Current range
- “**Setting 04**” Clamp sensor
- “**Setting 05**” VT ratio (if necessary)
- “**Setting 06**” CT ratio (if necessary)

- Keys

Key		Description
	<b>START/STOP</b> key	No use
	<b>BACKLIGHT</b> key	Switches on/off the backlight of the LCD.
	<b>UP cursor</b> key <b>DOWN cursor</b> key	Changes the display contents. Selects the row to be changed while in custom display mode.
	<b>LEFT cursor</b> key <b>RIGHT cursor</b> key	Changes the display contents. Selects the parameter (V, A etc.) to be displayed while in custom display mode
	<b>ENTER</b> key	Selects/ Enters custom display mode. Confirms the deletion of a file in the internal memory.
	<b>ESC</b> key	Cancels a setting in custom display mode.
	<b>DATA HOLD</b> key	Holds the indicated value on the LCD.
		Pressing this key for at least 2 sec. disables all key operations to prevent operation mistake during a measurement.
	<b>SAVE</b> key	Saves the measured data.

- Indication at no input

When no voltage and current are input, indication on the LCD will be as follows. Refer to “6-5-2 Over-range indication/ Bar indication” in this manual.

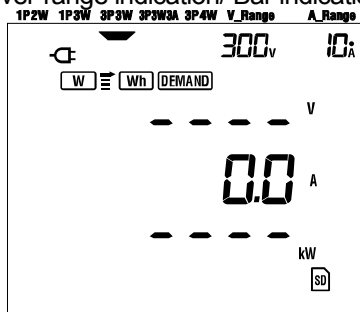

## 6.1 Wiring Configuration display screen

The start-up screens (or the screen after system reset) corresponding to each wiring configuration are listed below.

When turning the Function switch from “OFF” to **W** range, the following measurement screen appears.

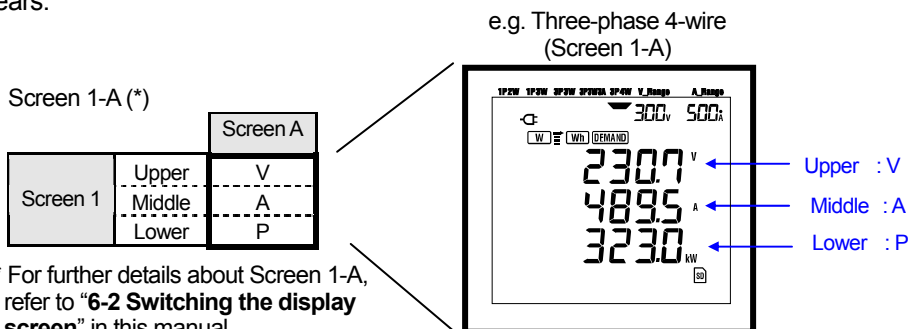

\* For further details about Screen 1-A, refer to “6-2 Switching the display screen” in this manual.

### • Three-phase 4-wire “3P4W” (16 screens)

		Screen A	Screen B	Screen C	Screen D	Screen E	Screen F	Screen G	Screen H
Screen 1	Upper	V	V1	V2	V3	—	—	—	—
	Middle	A	A1	A2	A3	—	—	—	—
	Lower	P	P1	P2	P3	—	—	—	—
Screen 2	Upper	P	P1	P2	P3	—	—	—	—
	Middle	S	S1	S2	S3	—	—	—	—
	Lower	PF	PF1	PF2	PF3	—	—	—	—
Screen 3	Upper	V1	A1	P1	PF1	S1	Q1	f	VL12
	Middle	V2	A2	P2	PF2	S2	Q2	In	VL23
	Lower	V3	A3	P3	PF3	S3	Q3	—	VL31

### • Three-phase 3-wire (3 clamp sensor) “3P3W3A” (15 screens)

		Screen A	Screen B	Screen C	Screen D	Screen E	Screen F	Screen G
Screen 1	Upper	V	V1	V2	V3	—	—	—
	Middle	A	A1	A2	A3	—	—	—
	Lower	P	P1	P2	P3	—	—	—
Screen 2	Upper	P	P1	P2	P3	—	—	—
	Middle	S	S1	S2	S3	—	—	—
	Lower	PF	PF1	PF2	PF3	—	—	—
Screen 3	Upper	V1	A1	P1	PF1	S1	Q1	f
	Middle	V2	A2	P2	PF2	S2	Q2	—
	Lower	V3	A3	P3	PF3	S3	Q3	—

• **Single-phase 3-wire “1P3W”, Three-phase 3-wire “3P3W” (13 screens)**

		Screen A	Screen B	Screen C	Screen D	Screen E	Screen F	Screen G
Screen 1	Upper	V	V1	V2	—	—	—	—
	Middle	A	A1	A2	—	—	—	—
	Lower	P	P1	P2	—	—	—	—
Screen 2	Upper	P	P1	P2	—	—	—	—
	Middle	S	S1	S2	—	—	—	—
	Lower	PF	PF1	PF2	—	—	—	—
Screen 3	Upper	V1	A1	P1	PF1	S1	Q1	f
	Middle	V2	A2	P2	PF2	S2	Q2	—
	Lower	—	—	—	—	—	—	—

• **Single-phase 2-wire (3ch) “1P2W (3ch)” (15 screens)**

		Screen A	Screen B	Screen C	Screen D	Screen E	Screen F	Screen G
Screen 1	Upper	V	V	V	V	—	—	—
	Middle	A	A1	A2	A3	—	—	—
	Lower	P	P1	P2	P3	—	—	—
Screen 2	Upper	P	P1	P2	P3	—	—	—
	Middle	S	S1	S2	S3	—	—	—
	Lower	PF	PF1	PF2	PF3	—	—	—
Screen 3	Upper	V	A1	P1	PF1	S1	Q1	f
	Middle	—	A2	P2	PF2	S2	Q2	—
	Lower	—	A3	P3	PF3	S3	Q3	—

• **Single-phase 2-wire (2ch) “1P2W (2ch)” (13 screens)**

		Screen A	Screen B	Screen C	Screen D	Screen E	Screen F	Screen G
Screen 1	Upper	V	V	V	—	—	—	—
	Middle	A	A1	A2	—	—	—	—
	Lower	P	P1	P2	—	—	—	—
Screen 2	Upper	P	P1	P2	—	—	—	—
	Middle	S	S1	S2	—	—	—	—
	Lower	PF	PF1	PF2	—	—	—	—
Screen 3	Upper	V	A1	P1	PF1	S1	Q1	f
	Middle	—	A2	P2	PF2	S2	Q2	—
	Lower	—	—	—	—	—	—	—

• **Single-phase 2-wire (1ch) “1P2W (1ch)” (9 screens)**

		Screen A	Screen B	Screen C	Screen D	Screen E	Screen F	Screen G
Screen 1	Upper	V	—	—	—	—	—	—
	Middle	A	—	—	—	—	—	—
	Lower	P	—	—	—	—	—	—
Screen 2	Upper	P	—	—	—	—	—	—
	Middle	S	—	—	—	—	—	—
	Lower	PF	—	—	—	—	—	—
Screen 3	Upper	V	A	P	PF	S	Q	f
	Middle	—	—	—	—	—	—	—
	Lower	—	—	—	—	—	—	—

**NOTE**

\* Parameters on each screen can be changed.

Refer to “6-3 Customizing the display” in this manual.

## 6.2 Selecting/changing the display screen

The display screens are classified as follows. Following table is also used in section “6-3 Customizing the display”.



	Screen A	Screen B	Screen C	Screen D	Screen E	Screen F	Screen G
Screen 1	Screen 1-A	Screen 1-B	Screen 1-C	Screen 1-D	—	—	—
Screen 2	Screen 2-A	Screen 2-B	Screen 2-C	Screen 2-D	—	—	—
Screen 3	Screen 3-A	Screen 3-B	Screen 3-C	Screen 3-D	Screen 3-E	Screen 3-F	Screen 3-G

\* In case of single-phase 2-wire (1ch), the following screens do not appear:  
1-B, 1-C, 1-D, 2-B, 2-C, 2-D

\* In case of single-phase 2-wire (2ch), single-phase 3-wire and three-phase 3-wire, the following screens do not appear:  
1-D and 2-D

### • Selecting the display screens

Upon turning the Function Switch from “OFF” to **W** range, Screen 1-A is displayed. Use the **Cursor** keys to select other screens.

	Selects from Screen A to G.
	Selects from Screen 1 to 3.

### NOTE

Turning off the instrument or changing the wiring configuration (“**Setting 01**”) on **SET UP** range returns screen 1-A.

• Selecting display screens

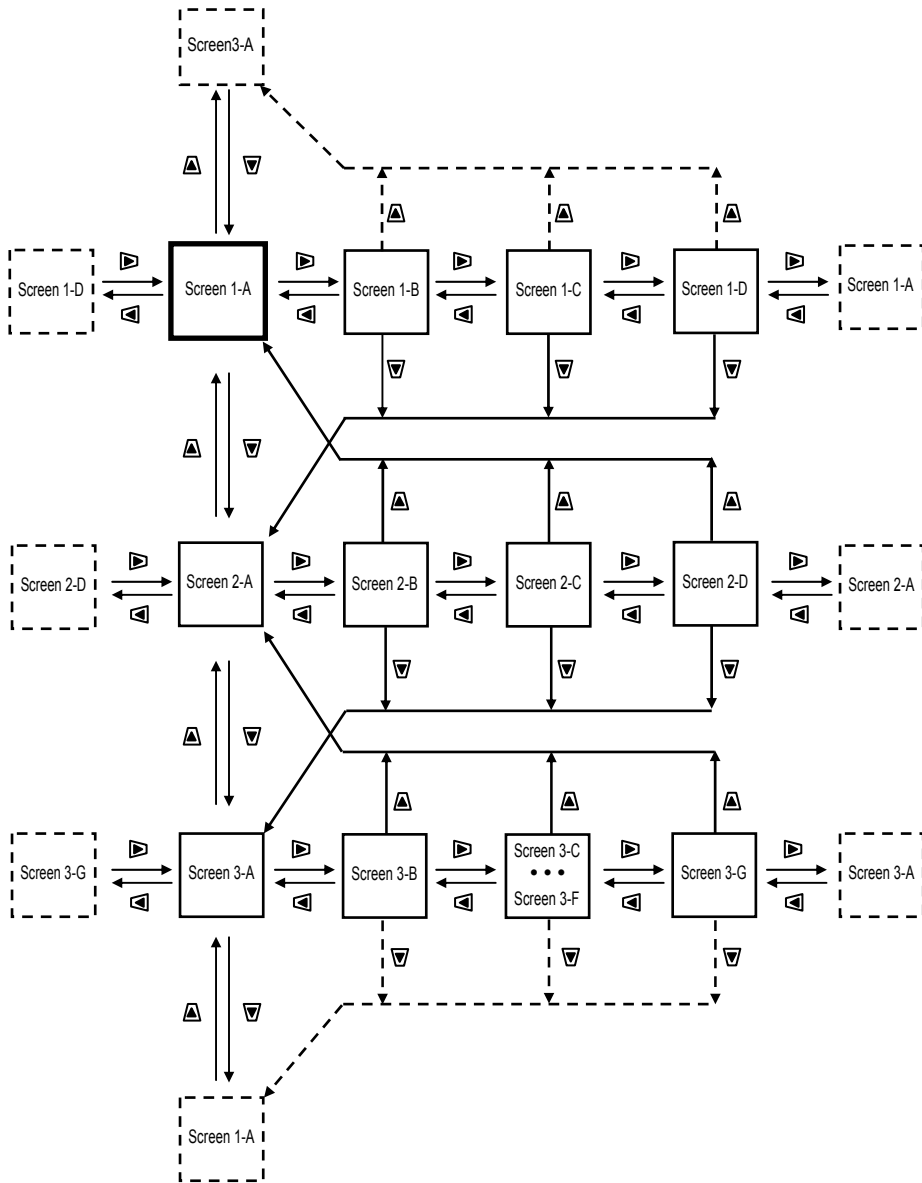



• Display examples

The following are examples of displays with three-phase 4-wire configuration.

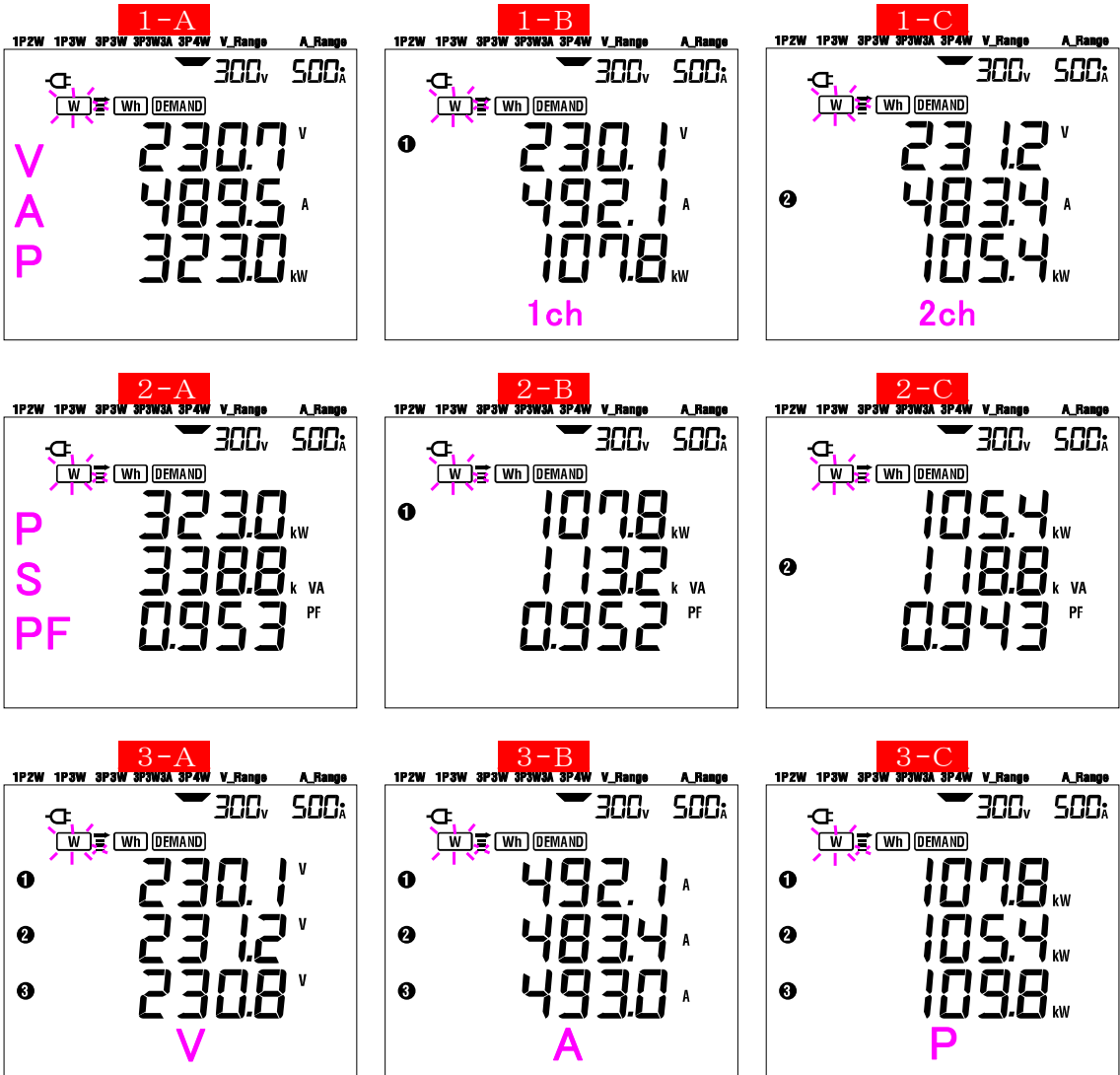

## 6.3 Customizing the display

The displayed parameters in the upper/middle/lower rows of Screen 1 and 2 can be customized. Screen 3 cannot be customized.

- **Example**

Displayed at:	Before customizing (*)	After customizing
Upper	V : Voltage	P : Active power
Middle	A : Current	PF : Power factor
Lower	P : Active power	A : Current
Screen 1		
Screen 2		
Upper	P : Active power	f : Frequency
Middle	S : Apparent power	A : Current
Lower	PF : Power factor	P : Active power

\* It is the start up screen or the previously customized screen that is displayed here. After system reset the start up screen is displayed. In the above example, start-up screen is displayed.

• Customizing

- 1 Press the **ENTER** key either on Screen 1 or 2, to enter into custom display mode.
- 2 Parameter displayed in upper row {eg. initial value: Screen1/ V(Voltage), Screen 2/P(Active power) } will flicker.
- 3 Select the row to be customized using the **UP or DOWN** cursor key and the parameter to be selected with **LEFT or RIGHT** cursor key.
- 4 When customizing other rows, select the row and parameters in same way.
- 5 Select any parameter you want to display it at each row, and press the **ENTER** key.

**Selecting row**

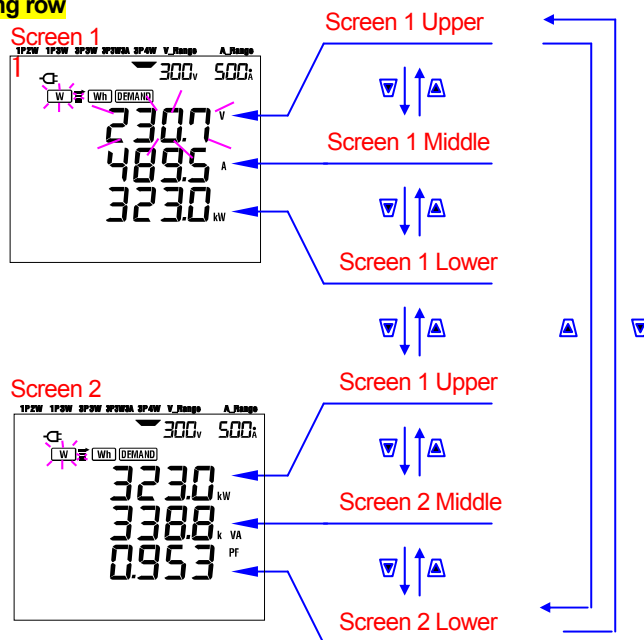

**Selecting parameters**

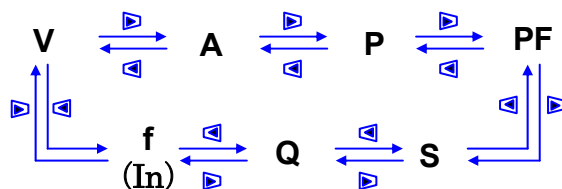

**NOTE**

- \* "P" can be customized only at the upper row, and "In" can be displayed only at the middle row. (when wiring configuration is three-phase 4-wire)
- \* On pressing the **ENTER** key whilst on Screen 3, the instrument will display Screen 1-A custom mode.
- \* Customizing cannot be done during an integration/ demand measurement whilst a survey is underway. This applies also for integration/demand stand by mode.
- \* After system reset, start-up screen appears.
- \* Pressing the **ESC** key during custom display mode restores the original displayed parameters.

## 6.4 Saving data (instantaneous values)

Pressing the **SAVE** key on **W** range during a measurement saves all the measured parameters at the instant of saving. This is a manual single step operation.

Data can be saved to either below two locations:

- \* **SD card** : Max. 511 files can be saved.
- \* **Internal memory** : Max. 4 files can be saved.

Data is saved to a SD card automatically when a SD card has been inserted. If a SD card has not been inserted, data is automatically saved to internal memory.

### 6.4.1 Saving Procedure

- 1 Press the **SAVE** key whilst on the **W** range .
- 2 The File number screen appears and the instantaneous measured data is saved.  
(A file number is assigned automatically.)
- 3 On the measurement screen, it can be seen that a file is open.

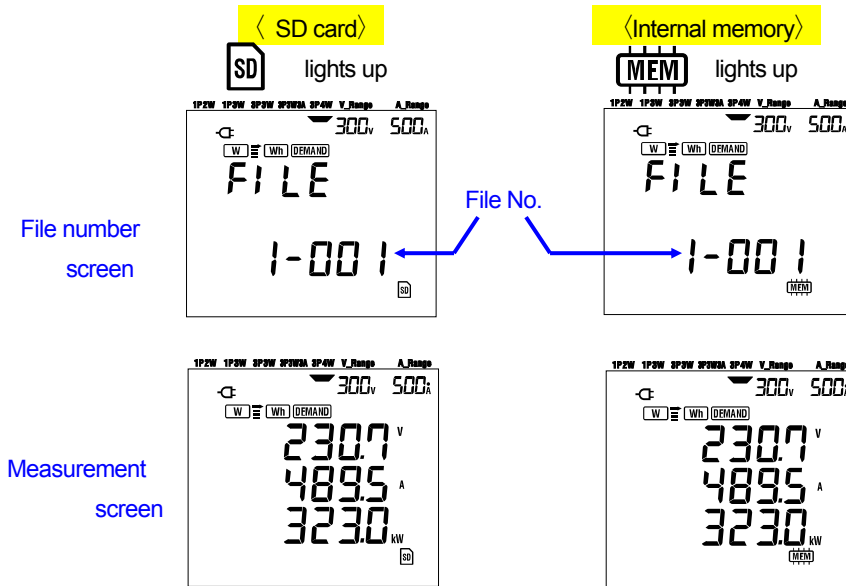

- 4 Subsequent measured data can be saved by pressing the **SAVE** key with a file already opened.

- 5 **Closing a file.** On completion of the data gathering, the file has to be closed. Set the Function switch to any range **other than "OFF"** and **W**. (eg. **WIRING CHECK**)

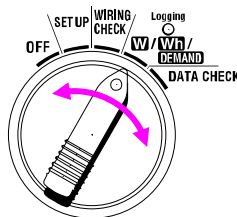

Each time the **SAVE** key is pressed; the measured data is saved in the same file. To save the data into an other file (only when SD card is used), press the **SAVE** key again on **W** range. Then repeat the saving procedure.

#### NOTE

- \* When the Function switch is set to OFF position before closing a file, the file remains open and is not saved. Be sure to set it to any position other than OFF and **W**, thus closing the file.
- \* If the **SAVE** key is pressed continuously (2 times or more in 1sec.), the measured data may not be saved correctly.
- \* The file number becomes "001" when;
  - (1) the file number has exceeded 999
  - (2) after system reset
- \* If the same file no. exists, the old one will be overwritten.

### 6.4.2 Limitations of saving

Data cannot be saved by pressing the **SAVE** key during a measurement when:

#### <SD card>

- \* when number of files opened has exceeded 511.
- \* when the SD card memory capacity has been exceeded

**FULL** appears and further data cannot be saved. To save further data, previously saved files should be deleted via PC or by deleting all the data in the SD card by using "**Setting 19**".(refer to section 4 of this manual)

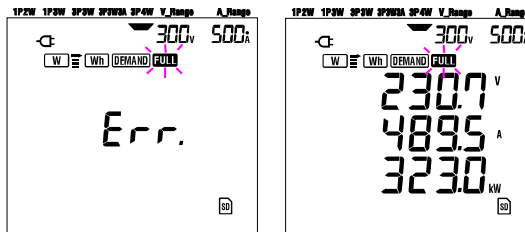

#### <Internal memory>

- \* when number of files opened has exceeded 4.
- \* when the capacity of internal memory has been exceeded.

**FULL** appears and further data cannot be saved. To save further data, previously saved files should be deleted by using "**Setting 21**".(refer to section 4 of this manual)

### 6-4-3 Parameters recorded

- **Parameters saved** (depending on each wiring configuration)  
Following parameters are saved.

Measurement/ calculation parameter	
Voltage (RMS)	Vi : Voltage per phase
Current (RMS)	Ai : Current per phase
Active power	P : Total active power    Pi : Active power per phase
Reactive power	Q : Total reactive power    Qi : Reactive power per phase
Apparent power	S : Total apparent power    Si : Apparent power per phase
Power factor	PF : Power factor of whole system    PFi: Power factor per phase
Frequency	f : Frequency of V1
Neutral current	In : Neutral Current

\* i = 1, 2, 3

- **File format and name**

Data is saved in KEW format, and the file name is assigned automatically as follows:

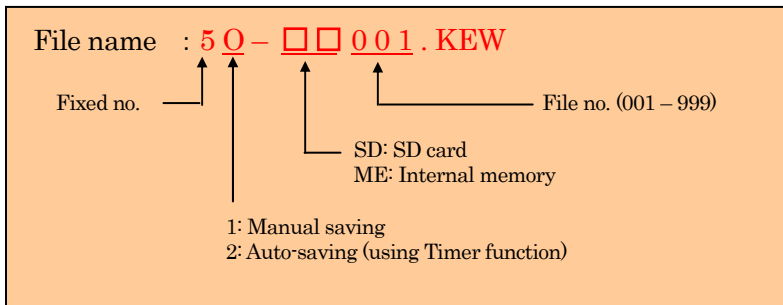

• **Example**

After downloading the file (SD card or internal memory), if the file is opened with a spreadsheet application software( using KEW format, eg Microsoft Excel), the spreadsheet will be as follows:

FILE ID	6305	← model" 6305"
VERSION	1_01	← Software version
SERIAL NUMBER	01234567	← s/n
MAC ADDRESS	00_11_22_33_44_55	← Bleutooth address
ID NUMBER	00-001	← Setting 23
CONDITION	---	← No
WIRING	3P4W	← Setting 01
VOLT RANGE	300V	← Setting 02
VT RATIO	1.00	← Setting 05
SENSOR TYPE	8125	← Setting 03
CURRENT RANGE	500A	← Setting 04
CT RATIO	1.00	← Setting 06
INTERVAL	---	← No
START	---	← No
DEMAND TARGET	---	← No
DEMAND INTERVAL	---	← No

	DATE	TIME	V1	V2	V3	A1	A2	A3	P	P1	P2	P3
*1	2012/01/10	12:34:56										
*2	2012/01/10	12:35:00										
*3	...	...	...	...	...	...	...	...	...	...	...	...

PF	PF1	PF2	PF3	S	S1	S2	S3	Q	Q1	Q2	Q3	f	In

- \*1: this is the data saved when **SAVE** key is pressed for the first time.
- \*2: this is the second data point saved when the **SAVE** key is pressed again whilst the file is still open.
- \*3: these are subsequent data points saved whenever the **SAVE** key is pressed whilst the file is still open.

Data will be displayed in exponential format. (e.g. when V1 is 100.1V, "1.001E+2").

## 6-5 Ranges and Over-range indication

### 6-5-1 Ranges

The settings determine the range for each measurement parameter, namely:

Voltage range (“**Setting 02**”), Current range (“**Setting04**”), VT ratio (“**Setting 05**”) and CT ratio (“**Setting 06**”). (Fixed range)

- **Voltage V:** V(average of each phase), V1/V2/V3 (each phase), max 4 digits  
150 / 300 / 600V range

Voltage range x VT ratio x 120%	Digit & Decimal point position
0.3600 - 0.9999 V	0.9999 V
1.000 - 9.999 V	9.999 V
10.00 - 99.99 V	99.99 V
100.0 - 999.9 V	999.9 V
1.000k - 9.999 kV	9.999 kV
10.00k - 99.99 kV	99.99 kV
100.0k - 999.9 kV	999.9 kV
1.000M - 7.200 MV	7.200 MV

- **Current A:** A(average of each phase), A1/A2/A3 (each phase), max 4 digits  
50AClamp sensor : 1 / 5 / 10 / 25 / 50A range  
100AClamp sensor : 2 / 10 / 20 / 50 / 100A range  
200AClamp sensor : 4 / 20 / 40 / 100 / 200A range  
500AClamp sensor : 10 / 50 / 100 / 250 / 500A range  
1000AClamp sensor : 50 / 100 / 200 / 500 / 1000A range  
3000AClamp sensor : 300 / 1000 / 3000A range

Current range x CT ratio x 120%	Digit & Decimal point position
0.0120 - 0.0999A	0.0999 A
0.1000 - 0.9999A	0.9999 A
1.000 - 9.999 A	9.999 A
10.00 - 99.99 A	99.99 A
100.0 - 999.9 A	999.9 A
1.000k - 9.999 kA	9.999 kA
10.00k - 99.99 kA	99.99 kA
100.0k - 999.9 kA	999.9 kA
1.000M - 9.999 MA	9.999 MA
10.00M - 36.00 MA	36.00 MA



● **Active power P/ Reactive power Q/ Apparent power S**

: P1 / P2 / P3, Q1 / Q2 / Q3, S1 / S2 / S3, max 4 digits

: P, Q, S (total), max 5 digits

Power (*) x VT ratio x CT ratio x 120%	Digit & Decimal point position
0.0030 ~ 0.0099 W / Var / VA	0.0099 W / Var / VA
0.0100 - 0.0999 W / Var / VA	0.0999 W / Var / VA
0.1000 - 0.9999 W / Var / VA	0.9999 W / Var / VA
1.000 - 9.999 W / Var / VA	9.999 W / Var / VA
10.00 - 99.99 W / Var / VA	99.99 W / Var / VA
100.0 - 999.9 W / Var / VA	999.9 W / Var / VA
1.000k - 9.999k W / Var / VA	9.999 k W / Var / VA
10.00k - 99.99k W / Var / VA	99.99 k W / Var / VA
100.0k - 999.9k W / Var / VA	999.9 k W / Var / VA
1.000M - 9.999M W / Var / VA	9.999 M W / Var / VA
10.00M - 99.99M W / Var / VA	99.99 M W / Var / VA
100.0M - 999.9M W / Var / VA	999.9 M W / Var / VA
1.000G - 9.999G W / Var / VA	9.999 G W / Var / VA
10.00G - 99.99G W / Var / VA	99.99 G W / Var / VA
100.0G - 999.9G W / Var / VA	999.9 G W / Var / VA
1000G - 180000G W / Var / VA	180000G W / Var / VA

\* The table shows values of power corresponding to each voltage and current range.

Voltage range	Current range							
	1.000A	2.000A	4.000A	5.000A	10.00A	20.00A	25.00A	40.00A
150.0V	150.0	300.0	600.0	750.0	1.500k	3.000k	3.750k	6.000k
300.0V	300.0	600.0	1.200k	1.500k	3.000k	6.000k	7.500k	12.00k
600.0V	600.0	1.200k	2.400k	3.000k	6.000k	12.00k	15.00k	24.00k
	50.00A	100.0A	200.0A	250.0A	300.0A	500.0A	1000A	3000A
150.0V	7.500k	15.00k	30.00k	37.50k	45.00k	75.00k	150.0k	450.0k
300.0V	15.00k	30.00k	60.00k	75.00k	90.00k	150.0k	300.0k	900.0k
600.0V	30.00k	60.00k	120.0k	150.0k	180.0k	300.0k	600.0k	1.800G

The above listed power values apply to single-phase 2-wire(1ch). The power for a single-phase 2-wire(2ch)/single-phase 3-wire/ three-phase 3-wire system will be twice that of the above values. Total power of the individual phases of a single-phase 2-wire(3ch)/ three-phase 4-wire system will be three times that of the above values.

● **Power factor PF:** PF (whole system), PF1/PF2/PF3 (each phase), 4 digits

Display range
-1.000 - 1.000 PF

● **Frequency f:** 3 digits

Display range
40.0 - 70.0 Hz

● **Neutral current In (A)** (only for three-phase 4-wire system): max 5 digits

Decimal point and the unit are same as for **Current**.

## 6-5-2 Over-range indication/ Bar indication

### **WARNING**

- When the over-range indication appears on the maximum chosen range, this means that the input exceeds the maximum allowable input for the instrument. Never apply such an input to the instrument.
- When a measured value exceeds the maximum allowable input, the use of VT/CT's is recommended. Refer to "5-3 VT/ CT" and follow the instruction manual.

### **CAUTION**

- When over-range indication appears on the screen, calculations are still performed. However their accuracy may not be guaranteed.

#### • Over-range indication

The Over-range indication appears when the parameters (Voltage V, Current A, Active power P, Reactive power Q, Apparent power S) exceed the following condition.

- \* Voltage V (V):  $> \text{Voltage range selected} \times \text{VT ratio} \times 130\%$   
(e.g.: when voltage range is 300V and VT ratio is 1: 390.0V)
- \* Current A (A):  $> \text{Current range} \times \text{CT ratio} \times 130\%$   
(e.g.: when current range selected is 200A and CT ratio is 2: 520.0A)
- \* Active power P (W)/ Reactive power Q (Var)/ Apparent power S (VA)  
:  $> \text{Power} \times \text{VT ratio} \times \text{CT ratio} \times 130\%$   
(e.g.: when power is 60kW, VT ratio is 1 and CT ratio is 2: 156.0kW)

#### < **OL** indication >

When any of the above conditions are met, " **OL** " is displayed.

#### < **V<sub>OL</sub>** mark >

When " **OL** " appears for over-range indication for any of V1, V2 and V3, this is displayed on the LCD. In this case, the **V<sub>OL</sub>** mark appears on all measurement screens on the **W** position.

#### < **A<sub>OL</sub>** mark >

When " **OL** " appears for over-range indication for any of A1, A2 and A3, this is displayed on the LCD. In this case, **A<sub>OL</sub>** mark appears on all measurement screens on the **W** position.

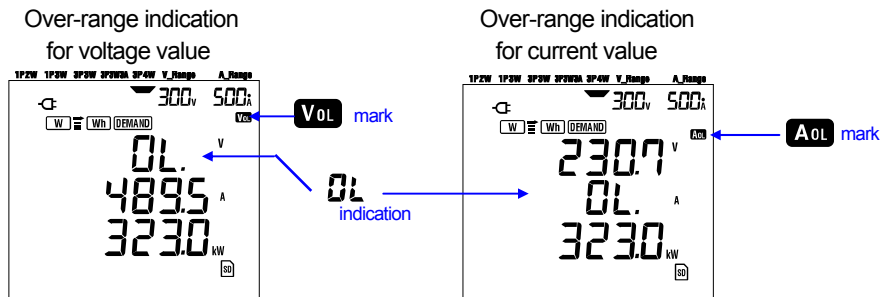

- **Bar indication**

The calculations and measurements performed by this instrument are based on the voltage and frequency of V1. If the value of V1 is less than 5% of the chosen range or if the frequency is not within 20 - 70Hz, all the parameters (except for current ) cannot be computed and thus displayed. In such a case, the numerical digits will be replaced by a bar indication (“- - -”) as shown:

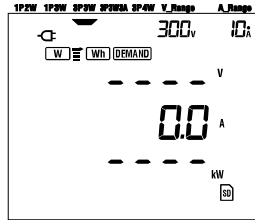

**NOTE:**

\* **VOL** or **AOL** mark is displayed every measurement screen while a measurement is performed on **Wh** or **DEMAND** range.

# 7. Integration value measurement

Set the Function switch to **Wh** range.

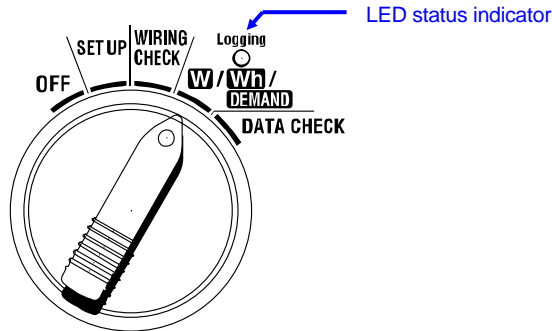

If the Function switch is set to the any other position during integration measurement or stand-by mode, the following happens;

- W** range : Confirms instantaneous values.  
(see “Section 6: Instantaneous value measurement”)
- DEMAND** range: No effect
- SET UP** range: Confirms the settings.  
(see “Section 4: Settings”)

• **Indications**

Measurement/Calculation Parameter		Unit
Active electrical energy (consumption)	WP : Total active electrical energy WP1/WP2/WP3 : Active electrical energy per phase	Wh
Apparent electrical energy (consumption)	WS : Total apparent electrical energy WS1/WS2/WS3 : Apparent electrical energy per phase	VAh
Elapsed time of integration	TIME : Hour; Min.; Sec. Hour; Min. Hour	-

**NOTE:**

- \* The above parameters vary depending on each wiring configuration.
- \* If V1 is out of measuring range, other parameters may not be measured or calculated.
- \* Only the consumed electrical energy is displayed on the screen.  
Regenerative energy will only be saved. Refer to “7.5.3 Saving data” in this manual.
- \* Displayed time changes with the elapsed time of integration.

● **Prior to making a measurement**

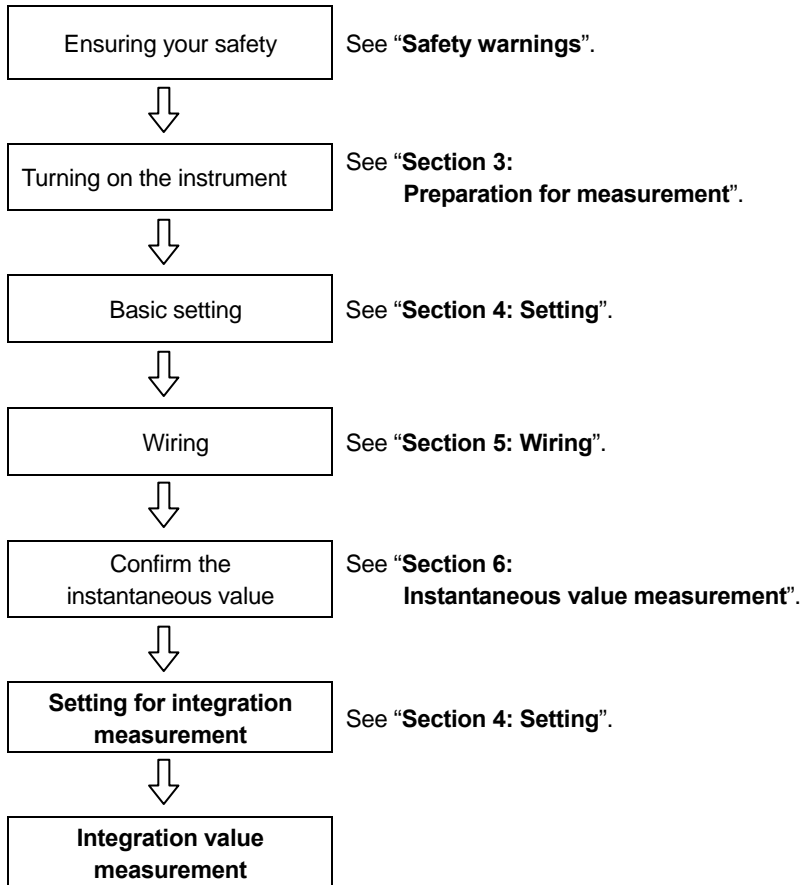









● **Settings for integration measurement**

Apart from basic settings the following settings are required for integration measurement.

- “**Setting 09**” Recording interval
- “**Setting 10**” Specific time period rec. or endless rec.
- “**Setting 11**” Time period setting Time setting
- “**Setting 12**” Time period setting Date setting
- “**Setting 13**” Start of continuous measurement
- “**Setting 14**” End of continuous measurement

• Keys

Key		Description
	<b>START/STOP</b> key	Pressing this key starts/stops integration measurement manually or automatically.
	<b>BACKLIGHT</b> key	Switches on / off the backlight of the LCD.
	<b>UP cursor</b> key <b>DOWN cursor</b> key	Changes the display contents.
	<b>LEFT cursor</b> key <b>RIGHT cursor</b> key	Changes the display contents.
	<b>ENTER</b> key	Resets the integration value. Confirms the deletion of a file in the internal memory.
	<b>ESC</b> key	Resets the integration value.
	<b>DATA HOLD</b> key	Holds the indicated value on the LCD.
		Pressing this key for at least 2 sec. disables all key operations to prevent operation mistake during a measurement.
	<b>SAVE</b> key	No use

**NOTE:**

\* Data hold function is disabled while the instrument is in stand-by mode for integration measurement.

## 7-1 Survey initiation

There are two ways of starting a survey.

### (1) Manual operation

Pressing **START/STOP** key on **Wh** range for 2 sec. or more starts measurement.

### (2) Automatic operation (presetting the time and date)

Set the start time and date on the **SET UP** range ("Setting 10"), and then press **START/STOP** key on **Wh** range. The instrument goes into stand-by mode, and the measurement starts at the preset time and date.

#### • Manual measurement

- 1 Press the **START/STOP** key on **Wh** range for 2 secs. or more.
- 2 The file number screen is displayed for about 1 sec. followed by the measurement screen. The survey then starts. At this time, LED status indicator is on.

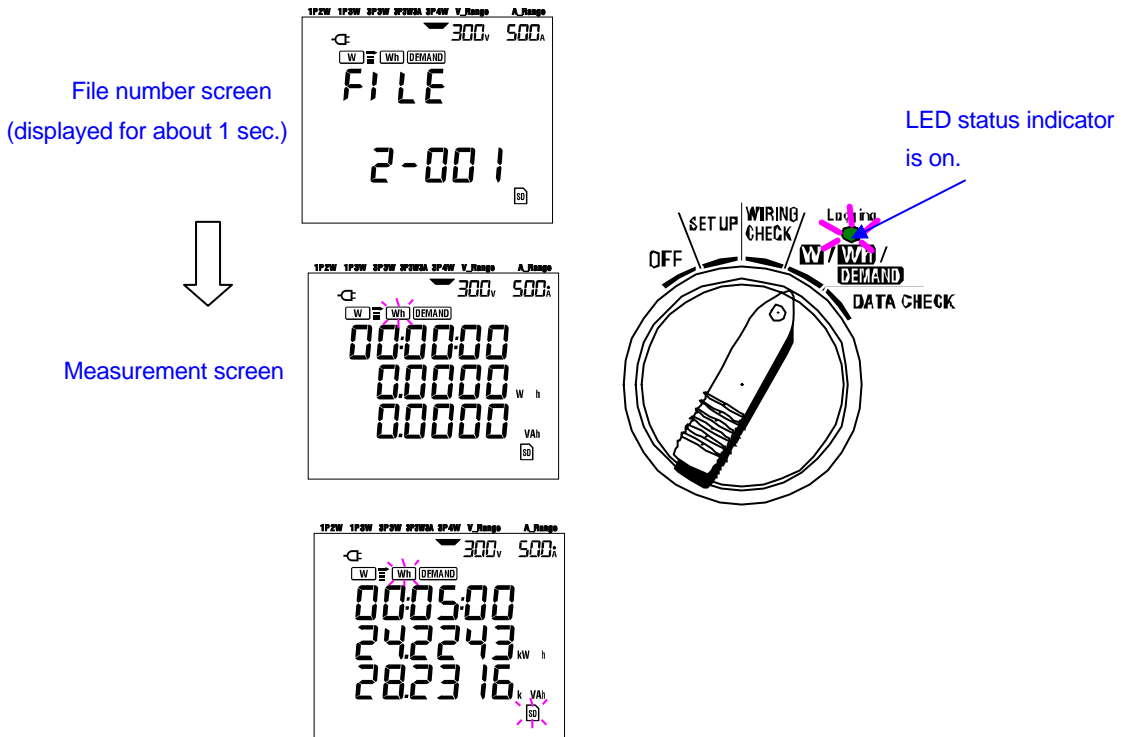

• **Automatic measurement** at a preset time and date

- 1 Preset the start time and date on **SET UP** range.
- 2 Set the Function switch to **Wh** range, and press the **START/STOP** key.
- 3 The file number screen is displayed for about 1 sec. (a file is opened), followed by the measurement screen. The instrument goes into stand-by mode. LED status indicator flicker while the instrument is in stand-by mode.

File number screen  
(displayed for about 1 sec.)

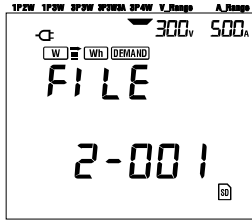

LED status indicator flickers



Measurement screen

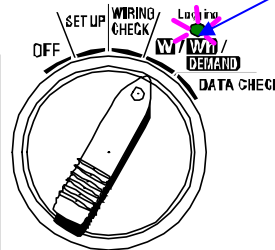
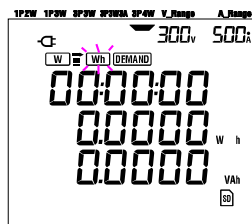

- 4 The survey starts at the preset time and date, and the LED status indicator stop flickering and are permanently on.

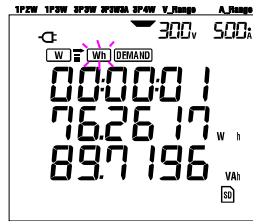

LED status indicator is on.

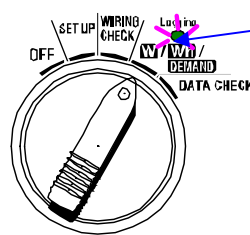

**NOTE:**

- \* The start time and date should be set after the current time in such a way to give enough time to the user to complete all settings before the survey starts.
- \* When the start time and date are set before the current time, measurement starts immediately upon pressing the **START/STOP** key.
- \* If the preset start time and date come after the preset stop time and date, the survey cannot be done.
- \* Even if the start and stop time have been preset and the instrument is in standby mode, pressing the **START/STOP** key at least 2 sec. releases the stand-by mode and start a survey in Manual mode. This renders the start/ stop time and date settings ineffective.



## 7.2 Survey closure

There are two ways of closing a survey.

### (1) Manual operation

Pressing **START/STOP** key on **Wh** range for 2 sec. or more closes the survey. This action also closes a survey started automatically at a preset time and date. LED status indicator goes off. The survey is then closed.

### (2) Automatic operation (presetting the time and date)

This can be done by presetting the stop time and date on **SET UP** range. LED status indicator goes off. The survey is then closed.

### NOTE

- \* A survey will be closed and lost when the instrument is switched off.
- \* Manually starting a survey renders a preset stop time and date ineffective. The survey has to be closed manually in this case.
- \* If the survey duration is shorter than the integration interval ("**Setting 09**") the measured data will not be saved.
- \* If the preset start time and date come after the preset stop time and date, the survey cannot be done.
- \* Pressing the **START/STOP** key 2 sec. or more releases the stand-by mode. LED status indicator goes off.

## 7.3 Resetting the integration value

There are two methods for resetting the integration value and period from previous measurements.

- a) Press **ESC** key on **Wh** range 2 sec. or more.
- b) System reset

### NOTE

- \* Integration value cannot be reset during a measurement or while the instrument is in stand-by mode.

## 7-4 Changing displays

Displays can be changed as follows with the **Cursor** keys. The parameters displayed vary depending on each wiring configuration chosen. Each calculated parameter, although not displayed on the screen, is actually being computed.

- **Changing the display** (Three-phase 4-wire configuration)

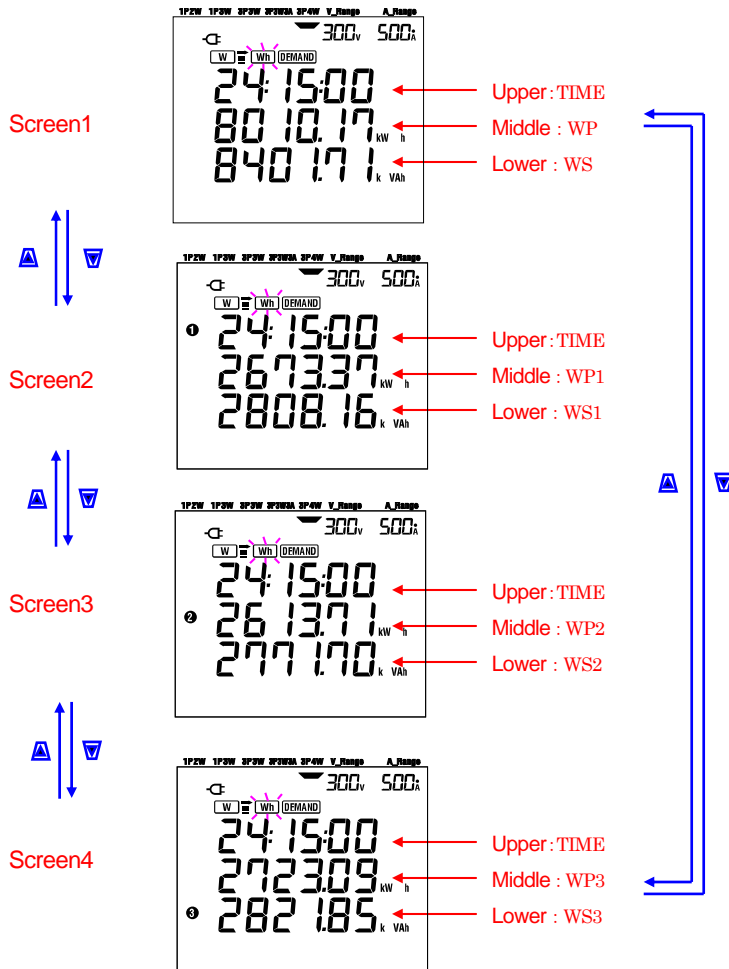

● **Indications on each wiring configuration**

The following messages are displayed on the screen according to each wiring configuration.

Wiring ("Setting 01")	Displayed at	Displayed contents			
		Screen1	Screen2	Screen3	Screen4
1P2W (1ch)	Upper	TIME			
	Middle	WP	-	-	-
	Lower	WS			
1P2W (2ch) 1P3W 3P3W	Upper	TIME	TIME	TIME	
	Middle	WP	WP1	WP2	
	Lower	WS	WS1	WS2	
1P2W (3ch) 3P3W3A 3P4W	Upper	TIME	TIME	TIME	TIME
	Middle	WP	WP1	WP2	WP3
	Lower	WS	WS1	WS2	WS3

Legend:

- TIME : Elapsed time of integration
- WP : Total active electrical energy
- WP1/WP2/WP3 : Active electrical energy per phase
- WS : Total apparent electrical energy
- WS1/WS2/WS3 : Apparent electrical energy per phase

## 7.5 Saving data

When integration or demand measurement starts, the measured data will be saved automatically.

There are two locations where data can be saved.

- \* **SD card** : Max. 511 files can be saved.
- \* **Internal memory** : Max. 4 files can be saved.

Data is saved to a SD card automatically when a SD card has been inserted before turning on the instrument. If the SD card has not been inserted, data is saved automatically to internal memory.

### 7.5.1 Saving Procedure

- \* When a survey is started (manually or automatically) a file is opened.
- \* Data is saved at the end of each integration interval ("Setting 09").

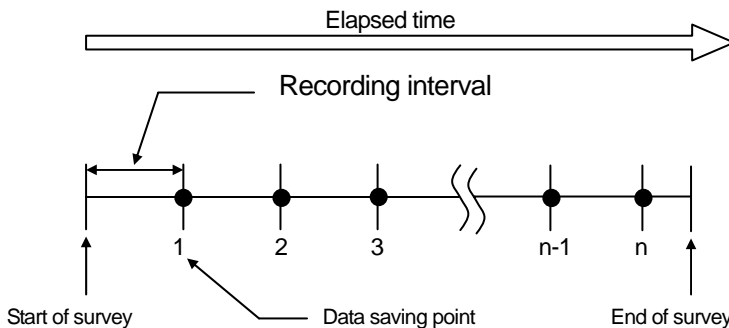

- \* When the survey is closed (manually or automatically) the file is closed
- \* All the recorded parameters at each data saving point are saved to one file.

## NOTE

- \* Never set the Function switch to OFF position during a survey otherwise the survey may be lost.
- \* The file number becomes "001" when;
  - (1) when the file number has exceeded 999
  - (2) after system reset
- \* If the same file no. exists, the old one will be overwritten.

## 7.5.2 Limitations of saving

### • Limitation of saving (before starting a survey)

In the following cases, a survey cannot be started (manually or automatically) by pressing the **START/STOP** key.

< In case data is saved to SD card >

- \* When 511 files have been saved to the SD card; **FULL** mark appears and further data cannot be saved.

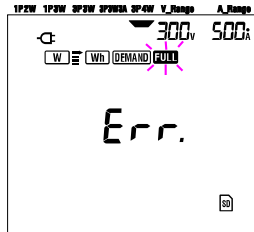

Some files can to be deleted via the PC, otherwise all the saved files in the SD card can be deleted using "Setting 19" of Section 4 in this manual.

< In case the data is saved to internal memory >

- \* When 4 files have been saved to the internal memory; **FULL** mark appears and further data cannot be saved.

### • Limitations of saving (during a survey)

When the capacity of SD card or internal memory has been exceeded during a survey; measurement continues but **FULL** mark appears on the display screen and further data will not be saved.

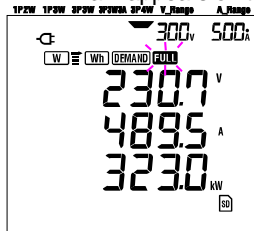

Press the **START/STOP** key 2 sec. or more and stop the survey once.  
Refer to preceding page and delete the unnecessary file.

## NOTE

- \* For further details about the capacity of the CF card and internal memory, refer to "Section 9: CF card/ Internal memory" in this manual.

### 7.5.3 Parameters Recorded

Depending on the wiring configuration chosen, the following parameters are recorded:

- Parameters to be saved

Parameters to be saved			
Voltage (RMS)	Vi : voltage of each phase Vi max : max. Vi values Vi min : min. Vi values Vi avg : avg. Vi values		
Current (RMS)	Ai : current of each phase Ai max : max. Ai values Ai min : min. Ai values Ai avg : avg. Ai values		
Active power	P : total active power P max : max. P value P min : min. P value P avg : avg. P value	Pi : active power of each phase Pi max : max. Pi values Pi min : min. Pi values Pi avg : avg. Pi values	
Reactive power	Q : total reactive power Q max : max. Q value Q min : min. Q value Q avg : avg. Q value	Qi : reactive power of each phase Qi max : max. Qi values Qi min : min. Qi values Qi avg : avg. Qi values	
Apparent power	S : total apparent power S max : max. S value S min : min. S value S avg : avg. S value	Si : apparent power of each phase Si max : max. Si values Si min : min. Si values Si avg : avg. Si values	
Power factor	PF : power factor of whole system PF max : max. PF value PF min : min. PF value PF avg : avg. PF value	PFi : power factor of each phase PFi max : max. PFi values PFi min : min. PFi values PFi avg : avg. PFi values	
Frequency	f : frequency of V1 f max : max. f value f min : min. f value f avg : avg. f value	Neutral current	In : current on neutral line In max : max. In value In min : min. In value In avg : avg. In value
Active energy (consumption) (regenerating) (overall)	+WP : total active energy (consumption) +WPi : active energy (consumption) of each phase -WP : total active energy (regenerating) -WPi : active energy (regenerating) of each phase #WP : total active energy (overall) #WPi : active energy (overall) of each phase		
Apparent energy (consumption) (regenerating) (overall)	+WS : total apparent energy (consumption) +WSi : apparent energy (consumption) of each phase -WS : total apparent energy (regenerating) -WSi : apparent energy (regenerating) of each phase #WS : total apparent energy (overall) #WSi : apparent energy (overall) of each phase		
Reactive energy (consumption)	+WQ : total reactive energy (consumption)		
Demand value	#DEM : total demand value TARGET : target demand value	#DEMi : demand value of each phase	

\* i = 1, 2, 3

where, "max." and "avg." mean maximum and average values during an interval.

• **File format and name**

Measured data is saved in KEW format, and the file name is assigned automatically.

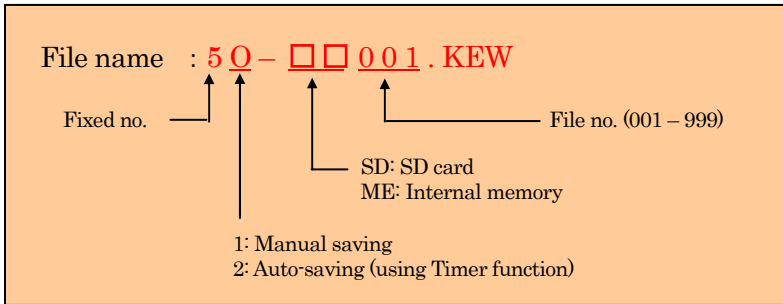

● Example of measured data

FILE ID	6305	← Model " 6305"
VERSION	1_01	← Software version
SERIAL NUMBER	01234567	← s/n
MAC ADDRESS	00_11_22_33_44_55	← Bluetooth address
ID NUMBER	00-001	← Setting 23
CONDITION	SELF	← No
WIRING	3P4W	← Setting 01
VOLT RANGE	300V	← Setting 02
VT RATIO	1.00	← Setting 05
SENSOR TYPE	8125	← Setting 03
CURRENT RANGE	500A	← Setting 04
CT RATIO	1.00	← Setting 06
INTERVAL	'30M	← Setting 09
START	yyy/mm/dd hh:mm:ss	← Setting 11 or 13
DEMAND TARGET	100.0kW	← Setting 15
DEMAND INTERVAL	30M	← Setting 16

\*Setting 15 and 16 are unrelated to integration measurement.

	DATE	TIME	ELAPSED TIME	V1	V2	V3	Q3	f	In
1	2012/01/10	09:00:00	00000:30:00						
2	2004/03/22	09:30:00	00001:00:00						
n	⋮	⋮	⋮	⋮	⋮	⋮	⋮	⋮	⋮

V1	V2	V3	Q3	f	In	V1	V2	V3	Q3	f	In
max	max	max	max	max	max	avg	avg	avg	avg	avg	avg
⋮	⋮	⋮	⋮	⋮	⋮	⋮	⋮	⋮	⋮	⋮	⋮

+	+	+	-	#	#	#	#	+	#	#	+	EM	DEM	Taeg
WP	WP1	WP2	WP3	WP	WP1	WP2	WP3	WS	WS2	WS3	WQ	2	3	et
⋮	⋮	⋮	⋮	⋮	⋮	⋮	⋮	⋮	⋮	⋮	⋮	⋮	⋮	⋮

Data will be displayed in exponential format. (e.g. 38672.1kWh, "3.86721E+7").

## 7.6 Displayed Digits/ Over-range indication

- **Digits**

- \* **Active electrical energy WP, Apparent electrical energy WS** (auto-range)

- : WP1/WP2/WP3, WS1/WS2/WS3 (each phase), max 6 digits

- : WP, WS (total), max 6 digits

The range is automatically assigned depending on the measured value.

The decimal point and unit are changed automatically.

Unit: Wh/ VAh		
0.0000	-	99..9999
100.000	-	999.999
1000.00	-	9999.99
10.0000 k	-	99.9999 k
100.000 k	-	999.999 k
1000.00 k	-	9999.99 k
10000.0 k	-	99999.9 k
100000 k	-	999999 k
1000.00 M	-	9999.99 M
10000.0 M	-	99999.9 M
100000 M	-	999999 M
1000.00 G	-	9999.99 G
10000.0 G	-	99999.9 G
100000 G	-	999999 G

When the value exceeds 999999G, segment becomes "OL".

However the saved data is not lost.

- \* **Elapsed time TIME**

Displayed time changes with time as follows.

Elapsed time		
00:00:00	~	99:59:59
		hour: minute: second
100	~	999999
		hour

- **Over-range indication/ others**

- \* When the input voltage and the current exceeds the max display counts, **V<sub>OL</sub>** or **A<sub>OL</sub>** mark is displayed on the LCD. In this case, accurate measurement cannot be made.

- \* On the **W** range, when the P (active power) is shown by bars " - - -", this means that the increment in electrical energy is insignificant.

Refer to "6-5-2 Over-range indication/ Bar indication" in this manual.





## 8. Demand value measurement

Set the Function switch to **DEMAND** range.

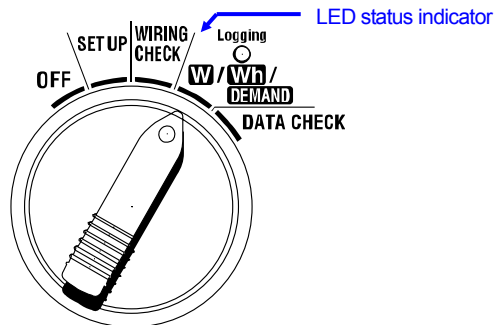

If the Function switch is set in the following positions during Demand measurement or Demand stand-by mode;

- W** range : The instantaneous values are displayed.  
(see “Section 6: Instantaneous value measurement”)
- Wh** range : The instantaneous values are displayed.  
(see “Section 7: Integration value measurement”)
- SET UP** range : The settings are displayed.  
(see “Section 4: Settings”)

### • Indications

Measurement/Calculation items	Unit
Target demand value	W
Predicted demand value	W
Present demand value	W
Load factor	%
Remaining time for demand interval elapse	-
Max. demand value recorded so far	W
Date and time when max. demand value was recorded	-

• **Before making a measurement**

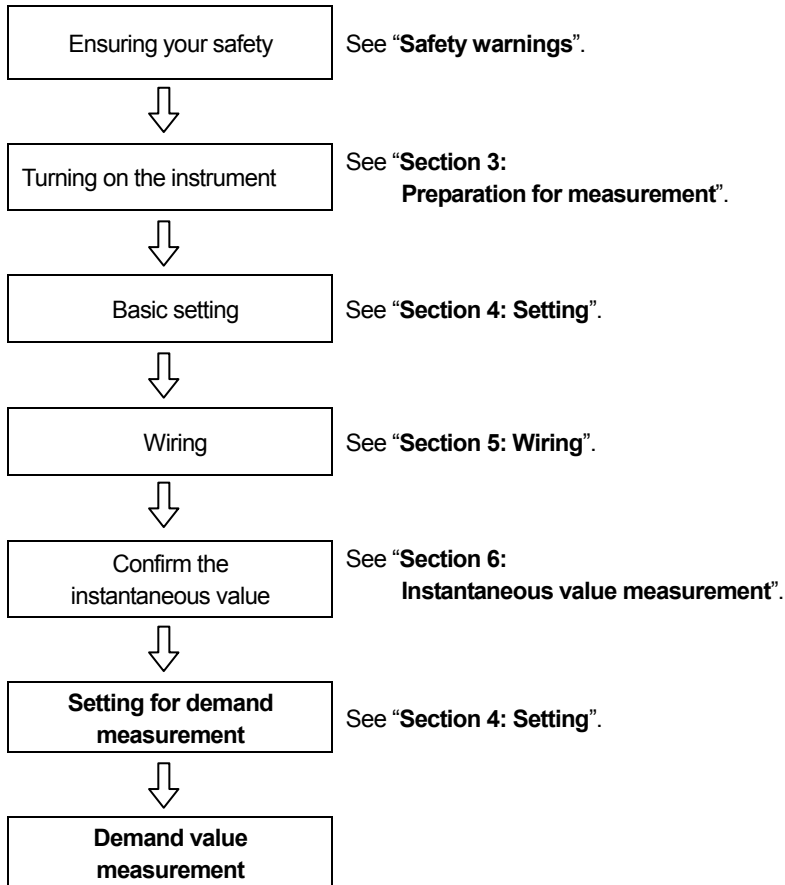

• **Settings only for demand measurement**

Basic setting and following settings are required for demand measurement.

“**Setting 09**” Recording interval

“**Setting 10**” Specific time period rec. or endless rec.

“**Setting 11**” Time period setting Time setting

“**Setting 12**” Time period setting Date setting

“**Setting 13**” Start of continuous measurement









“**Setting 14**” End of continuous measurement

“**Setting 15**” Target demand

“**Setting 16**” Demand measurement cycle

“**Setting 17**” Demand warning cycle

- Keys

	Key	Description
	<b>START/STOP</b> key	Pressing this key starts/stops demand measurement manually or automatically.
	<b>BACKLIGHT</b> key	Switches on/off the backlight of the LCD.
	<b>UP cursor</b> key <b>DOWN cursor</b> key	Changes the display contents.
	<b>LEFT cursor</b> key <b>RIGHT cursor</b> key	Changes the display contents.
	<b>ENTER</b> key	Resets the demand value. Confirms the deletion of a file in the internal memory.
	<b>ESC</b> key	Resets the demand value.
	<b>DATA HOLD</b> key	Holds the indicated values on the LCD.
		Pressing this key for at least 2 sec. locks all key operations to prevent measurement interruption
	<b>SAVE</b> key	No use

**NOTE**

\* Data hold function is disabled while the instrument is in stand-by mode for demand measurement.

## 8-1 Demand measurement

The following is an example of power management by monitoring the demand.

- **Reducing the average power during a specific interval**

Assume the interval to be 30mins.

In the figure below, the average power during Interval 1 is assumed to be 500kW and during Interval 2 is assumed to be 600kW.

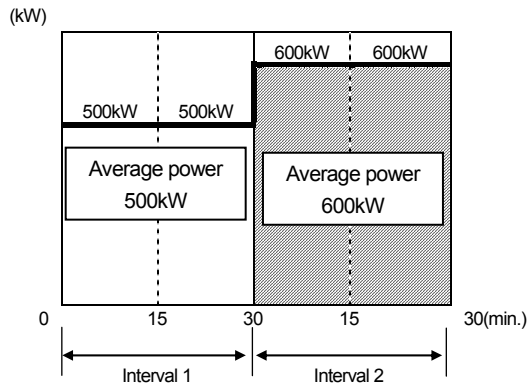

Now, assume that the average power during the first 15 min. (the inspection cycle) of Interval 2 is 600kW. The average power during Interval 2 can be maintained at 500kW (same as Interval 1) by reducing the power of the last 15 min. to 400kW.

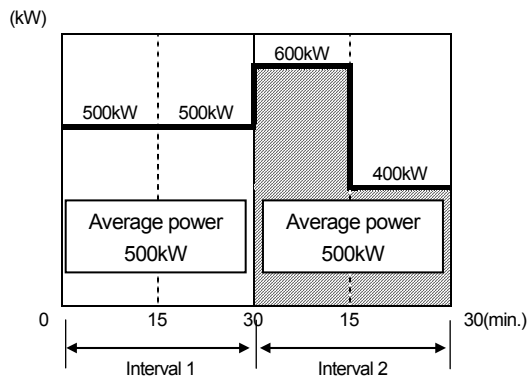

If say, the average power during the first 15 min. is 1000kW then the average power during the second 15min should be 0kW to maintain an average power of 500kW.

• **Demand measurement with this instrument**

By measuring loads, the KEW6305 can display the present and predicted average power(demand value). These values are continuously updated as time elapses during a particular interval.

The buzzer will sound when a predicted demand value exceeds a target demand value after the elapse of the preset inspection cycle.

The value which is displayed at the end of an interval (in this case, 30 min.) is the average power (Demand value) for the interval.

The figure below describes the relationship between: Target demand value, Predicted value, Present demand value, interval and inspection cycle

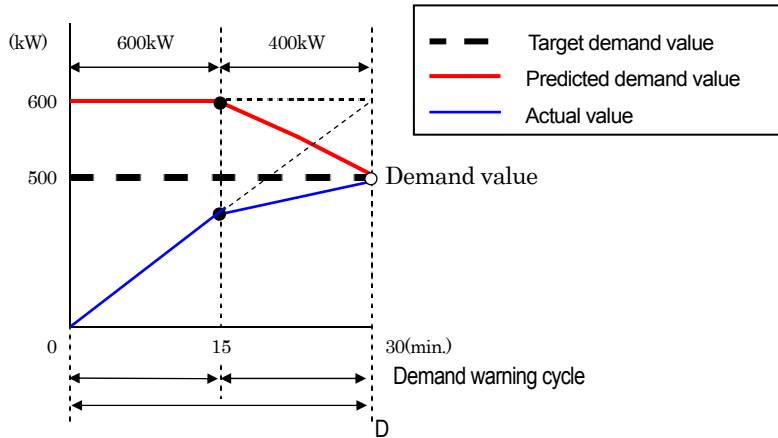

\* In this case, the demand value at the end of the interval is 500kW.

The demand values calculated at each interval are useful for power management per day, month or year.

**NOTE**

\* The readings of the demand meter installed by the power company and the KEW6305, may not match completely due to a time-lag in the start of intervals.

## • Saving Demand values

Demand values will be saved at the preset interval (Setting 09).

Final demand value is determined at the end of every demand measurement cycle (Setting 16), and will be reset automatically. The maximum demand value measured during every demand cycle will be held and displayed on the LCD together with the time and date information.

The following is an example of the saving status of a demand value survey where the demand interval is 10 min, demand cycle is 30 min and the survey duration is about 3 hours.

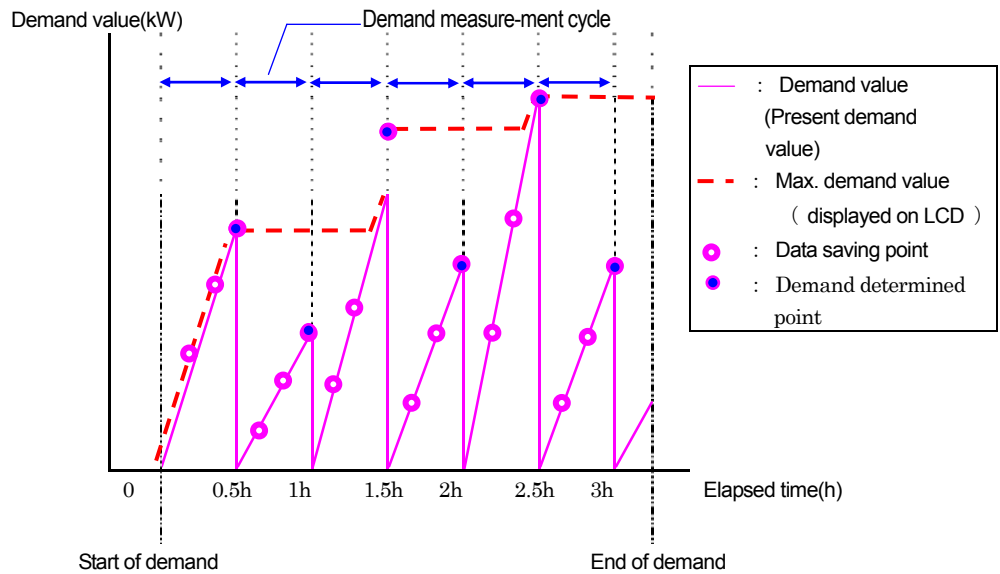

## 8-2 Changing displayed items

There are 3 display screens on **DEMAND** range, and the screens are common to each wiring configuration.

- Screens can be changed with **Cursor** keys as follows.

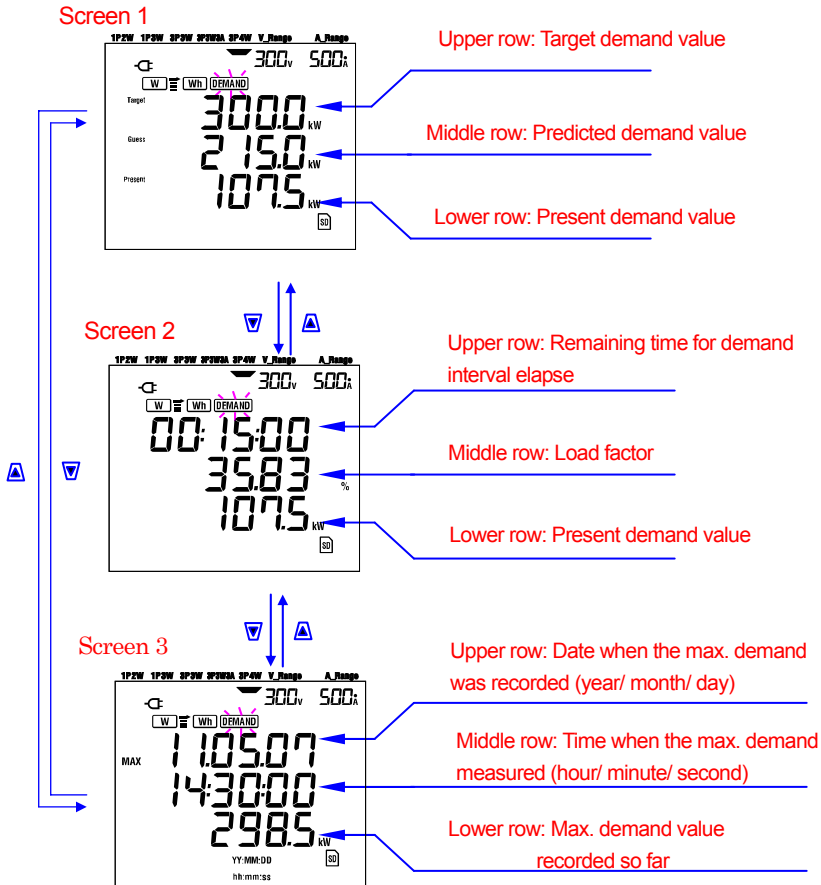



- **Displayed items**

<Screen 1, Upper row: **Target demand value** (W) >

It is set at "Setting 15". Set the desired value.

**Target**

<Screen 1, Middle row: **Predicted demand value** (W) >

Predicted values of average electrical power (demand values) which will be after the elapse of demand measurement interval with present loads are displayed right after starting a measurement. The predicted values are calculated successively when loads vary.

**Guess**

<Screen 1, Lower row & Screen 2, Lower row: **Present demand value** (W) >

This is the Present Demand Value(see definitions)

**Present**

<Screen 2, Upper row: **Remaining time**>

This is the count down, in 1 sec. decrements to the end of the interval.

<Screen 2, Middle row: **Load factor** (%) >

This is the load factor(See definitions)

<Screen 3, Upper row & Middle row: **Date and time** >

These are the time and when the max. demand recorded so far from the start of the survey was measured.

**MAX**

<Screen 3, Lower row: **Max. demand value** (W) >

The max. demand value measured between the beginning and the end of measurement is displayed.

**MAX**

## 8-3 Survey initiation

There are two methods to start a survey.

### (1) Manual operation

Pressing the **START/STOP** key on **DEMAND** range for at least 2 sec. starts measurement.

### (2) Automatic operation (preset time and date)

Set the start time and date on **SET UP** range, and then press the **START/STOP** key on **DEMAND** range. The instrument goes into stand-by mode, and the measurement starts at the preset time and date.

### • To start measurement manually

- 1 Press the **START/STOP** key on **DEMAND** range at least 2 sec.
- 2 File number screen is displayed for about 1 sec. (a file is opened), and then the measurement screen is displayed. After that, measurement starts. At this time, LED status indicator is on (GREEN).

File number screen  
(displayed for about 1 sec.)

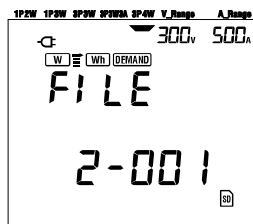

Measurement screen

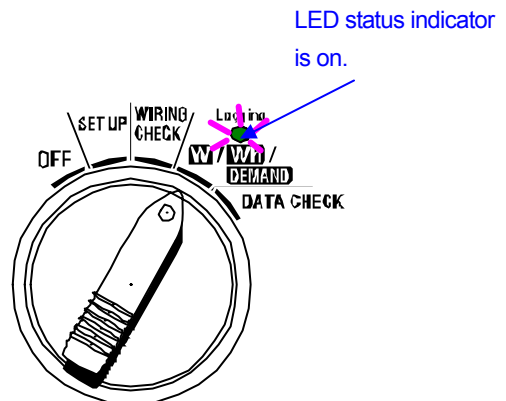
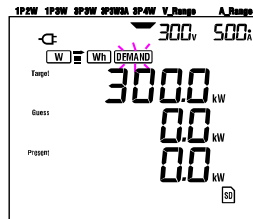

- To start measurement automatically at the preset time and date

- 1 Set the start time and date on **SET UP** range.
- 2 Then set the Function switch to **DEMAND** range, and press the **START/STOP** key.
- 3 File number screen is displayed for about **DEMAND**., followed by the measurement screen. The instrument goes into stand-by mode for measurement. LED status indicator while the instrument is in stand-by mode.

File number screen  
(displayed for about 1 sec.)



Measurement screen

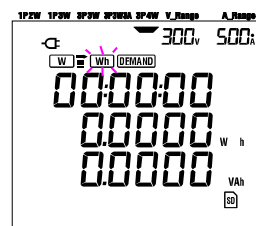
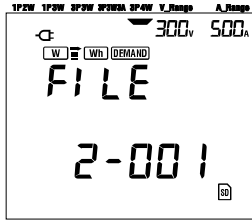

LED status indicator  
flickers

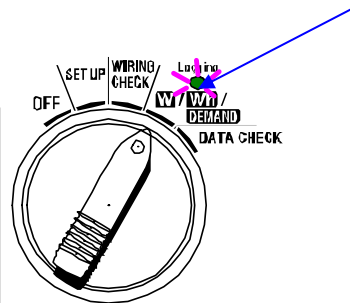

- 4 Measurement starts at the preset time and date, and the LED status indicator stop flickering and remain on for the duration of the survey.

LED status indicator  
is on.

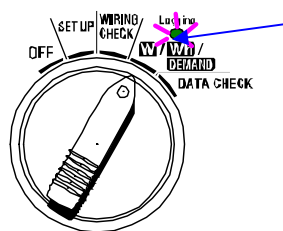
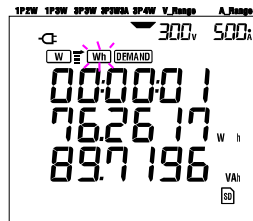

#### NOTE

- \* The start time and date should be set after the current time in such a way to give enough time to the user to complete all settings before the survey starts.
- \* When the start time and date are set before the current time, measurement starts immediately upon pressing the **START/STOP** key.
- \* When the preset start time and date come after the preset stop time and date, measurement stops right after the start of measurement.
- \* Even if the start and stop time have been preset and the instrument is in standby mode, pressing the **START/STOP** key at least 2 sec. will release the stand-by mode and start a survey in Manual mode. This renders the start/ stop time and date settings ineffective.

## 8-4 Survey closure

There are two methods for closing a survey.

### (1) Manual operation

Pressing **START/STOP** key on **DEMAND** range for at least 2 sec. stops measurement. This action also stops the measurement started automatically at a preset date and time.

### (2) Automatic operation (specifying the time and date)

Preset the stop time and date on **SET UP** range .

- To stop measurement manually

- \* Pressing **START/STOP** key on **DEMAND** range for at least 2 sec. stops the measurement. When it stops, (in case data is to be saved to CF card) the LED status indicator goes off.

- To stop measurement automatically at the preset time and date

- DEMAND** th **CARD** time and date on **SET UP** range. This method is available only when the measurement is started at the preset time and date. When the preset stop time and date has been reached, (in case data to be saved to CF card) and LED status indicator goes off. The survey is then closed.

### NOTE

- \* Turning off the instrument ( by setting the Function switch to OFF position) will stop the survey, however the measured data may be lost. It is recommended that a survey be stopped manually (**START/STOP** key) or by presetting the stop time and date.
- \* Manually starting a survey renders a preset stop time and date ineffective. The survey has to be closed manually in this case.
- \* If the preset start time and date come after the preset stop time and date, the survey cannot be done.

## 8-5 Resetting the demand value

There are two methods for resetting (deleting) the current demand values on the display screen.

- \* Press **ESC** key on **DEMAND** range at least 2 sec.
- \* System reset

### NOTE

- \* If it is desired to retain the integration value, start demand measurement without resetting the demand values. The items on **DEMAND** range other than the max. demand value and corresponding time and date, are reset automatically.
- \* Demand value cannot be reset during a measurement or while the instrument is in stand-by mode.

## 8-6 Saving data

When integration or demand measurement starts, the measured data will be saved automatically.

There are two locations where data can be saved.

\* **SD card** : **Max. 511 files can be saved.**

\* **Internal memory** : **Max. 4 files can be saved.**

Data is saved to a SD card automatically when a SD card has been inserted before turning on the instrument. If the SD card has not been inserted, data is saved automatically to the internal memory

### 8.6.1 Saving procedure

\* When a survey is started (manually or automatically) a file is opened

\* Data is saved at the end of each integration interval ("**Setting 09**").

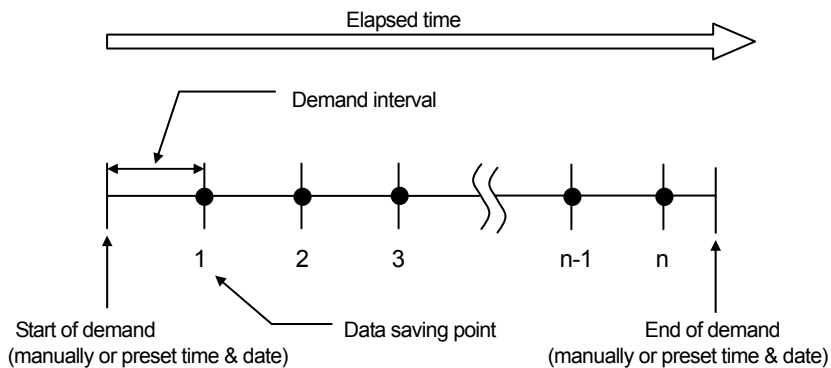

\* When the survey is closed (manually or automatically) the file is closed

\* All the recorded parameters at each data saving point are saved to one file.

#### NOTE

\* Never set the Function switch to OFF position during a survey otherwise the measured data may be lost.

\* In the following cases, the file number becomes "001":

(1) when the file number has exceeded 999;

(2) after system reset

\* If the same file no. exists, the old one will be overwritten.

## 8.6.2 Limitation of saving

- **Limitation of saving (before starting a survey)**

In the following cases, a survey cannot be started (manually or automatically) by pressing the **START/STOP** key.

< In case data is saved to SD card >

\* When 511 files have been saved to the SD card; **FULL** mark appears and further data cannot be saved.

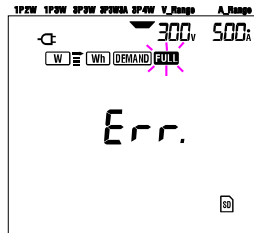

Some files can be deleted via the PC, otherwise all the saved files in the SD card can be deleted using "Setting 19" of Section 4 in this manual.

< In case the data is saved to internal memory >

\* When 4 files have been saved to the internal memory; **FULL** mark appears and further data cannot be saved.

- **Limitations of saving (during a survey)**

When the capacity of SD card or internal memory has been exceeded during a survey; measurement continues but **FULL** mark appears on the display screen and further data will not be saved.

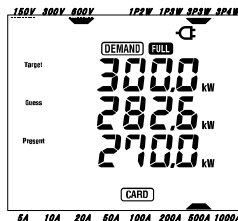

Press the **START/STOP** key 2 sec. or more and stop the survey once. Refer to preceding page and delete the unnecessary file.

- **File format and name**

Measured data is saved in KEW format, and the file name is assigned automatically.

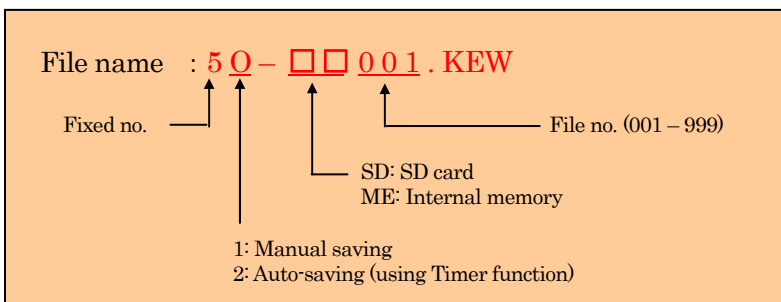

## 8-6-3 Parameters recorded

- Parameters to be saved

Parameters to be saved			
Voltage (RMS)	$V_i$ : voltage of each phase $V_i \max$ : max. $V_i$ values $V_i \min$ : min. $V_i$ values $V_i \text{ avg}$ : avg. $V_i$ values		
Current (RMS)	$A_i$ : current of each phase $A_i \max$ : max. $A_i$ values $A_i \min$ : min. $A_i$ values $A_i \text{ avg}$ : avg. $A_i$ values		
Active power	$P$ : total active power $P \max$ : max. $P$ value $P \min$ : min. $P$ value $P \text{ avg}$ : avg. $P$ value	$P_i$ : active power of each phase $P_i \max$ : max. $P_i$ values $P_i \min$ : min. $P_i$ values $P_i \text{ avg}$ : avg. $P_i$ values	
Reactive power	$Q$ : total reactive power $Q \max$ : max. $Q$ value $Q \min$ : min. $Q$ value $Q \text{ avg}$ : avg. $Q$ value	$Q_i$ : reactive power of each phase $Q_i \max$ : max. $Q_i$ values $Q_i \min$ : min. $Q_i$ values $Q_i \text{ avg}$ : avg. $Q_i$ values	
Apparent power	$S$ : total apparent power $S \max$ : max. $S$ value $S \min$ : min. $S$ value $S \text{ avg}$ : avg. $S$ value	$S_i$ : apparent power of each phase $S_i \max$ : max. $S_i$ values $S_i \min$ : min. $S_i$ values $S_i \text{ avg}$ : avg. $S_i$ values	
Power factor	$PF$ : power factor of whole system $PF \max$ : max. $PF$ value $PF \min$ : min. $PF$ value $PF \text{ avg}$ : avg. $PF$ value	$PF_i$ : power factor of each phase $PF_i \max$ : max. $PF_i$ values $PF_i \min$ : min. $PF_i$ values $PF_i \text{ avg}$ : avg. $PF_i$ values	
Frequency	$f$ : frequency of $V_1$ $f \max$ : max. $f$ value $f \min$ : min. $f$ value $f \text{ avg}$ : avg. $f$ value	Neutral current	$I_n$ : current on neutral line $I_n \max$ : max. $I_n$ value $I_n \min$ : min. $I_n$ value $I_n \text{ avg}$ : avg. $I_n$ value
Active energy (consumption) (regenerating) (overall)	$+WP$ : total active energy (consumption) $+WP_i$ : active energy (consumption) of each phase $-WP$ : total active energy (regenerating) $-WP_i$ : active energy (regenerating) of each phase $\#WP$ : total active energy (overall) $\#WP_i$ : active energy (overall) of each phase		
Apparent energy (consumption) (regenerating) (overall)	$+WS$ : total apparent energy (consumption) $+WS_i$ : apparent energy (consumption) of each phase $-WS$ : total apparent energy (regenerating) $-WS_i$ : apparent energy (regenerating) of each phase $\#WS$ : total apparent energy (overall) $\#WS_i$ : apparent energy (overall) of each phase		
Reactive energy (consumption)	$+WQ$ : total reactive energy (consumption)		
Demand value	$\#DEM$ : total demand value TARGET : target demand value	$\#DEMi$ : demand value of each phase	

\*  $i = 1, 2, 3$

where, "max." and "avg." mean maximum and average values during an interval.

• Example of measured data

FILE ID	6305	← Model " 6305"
VERSION	1_01	← Software version
SERIAL NUMBER	01234567	← s/n
MAC ADDRESS	00_11_22_33_44_55	← Bluetooth address
ID NUMBER	00-001	← Setting 23
CONDITION	SELF	← No
WIRING	3P4W	← Setting 01
VOLT RANGE	300V	← Setting 02
VT RATIO	1.00	← Setting 05
SENSOR TYPE	8125	← Setting 03
CURRENT RANGE	500A	← Setting 04
CT RATIO	1.00	← Setting 06
INTERVAL	'30M	← Setting 09
START	yyy/mm/dd hh:mm:ss	← Setting 11 or 13
DEMAND TARGET	100.0kW	← Setting 15
DEMAND INTERVAL	30M	← Setting 16

	DATE	TIME	ELAPSED TIME	V1	V2	V3	Q3	f	In
1	2012/01/10	09:00:00	00000:30:00						
2	2004/03/22	09:30:00	00001:00:00						
n	...	...	...	...	...	...	...	...	...

V1	V2	V3	Q3	f	In	V1	V2	V3	Q3	f	In
max	max	max	max	max	max	avg	avg	avg	avg	avg	avg
...	...	...	...	...	...	...	...	...	...	...	...

+	+	+	-	#	#	#	#	+	#	#	+	EM	DEM	Taeg
WP	WP1	WP2	WP3	WP	WP1	WP2	WP3	WS	WS2	WS3	WQ	2	3	et
...	...	...	...	...	...	...	...	...	...	...	...	...	...	...

Data will be displayed in exponential format. (e.g. 38672.1kWh, "3.86721E+7").



## 8-7 Displayed Digits/ Over-range indication

### •Digits

\*Predicted demand value (Guess), Present demand value (Present): max 6 digits

The digits of the predicted and present demand values are corresponding to the target demand values listed in the table below.

Target demand value ("Setting 16")	Digit and decimal point
0.1~999.9 W/VA	0.0~99999.9 W/VA
0.1~999.9 kW/kVA	0.0~99999.9 kW/kVA
0.1~999.9 MW/MVA	0.0~99999.9 MW/MVA
0.1~999.9 GW/GVA	0.0~99999.9 GW/GVA

\* Load factor (%):max 6 digits 9999.99%

### • Over-range indication/ others

When the predicted demand value, present demand value(max demand value) and load factor exceed 99999.9, segment becomes "OL".

\* When the input voltage and the current exceeds the max display counts, **VOL** or **AOL** mark is displayed on the LCD. In this case, accurate measurement cannot be made.

\* On the **W** range, when the P (active power) is shown by bars " - - - ", this means that the increment in electrical energy is insignificant.

Refer to "6-5-2 Over-range indication/ Bar indication" in this manual.

# 9. SD card/ Internal memory

## 9-1 Instrument and SD Card/ Internal memory

This instrument supports 1/ 2Gbyte SD cards.

- Max number of saved data

Destination to save data		SD card		Internal memory
Capacity		1GB	2GB	3MB
Manual saving ( <b>W</b> )		approx. 3.3 million results	approx. 6.7 million results	approx. 10,000 results
Auto-saving at preset interval	1 sec	approx. 8 days	approx. 17 days	approx. 33 min.
	1 min	approx. 16 months	approx. 33 months	approx. 33 hours
	30 min	3 years or more		approx. 42 days
Max number of file		511		4

\* In case that no file has been contained in SD card.

- File name

File name is assigned automatically.

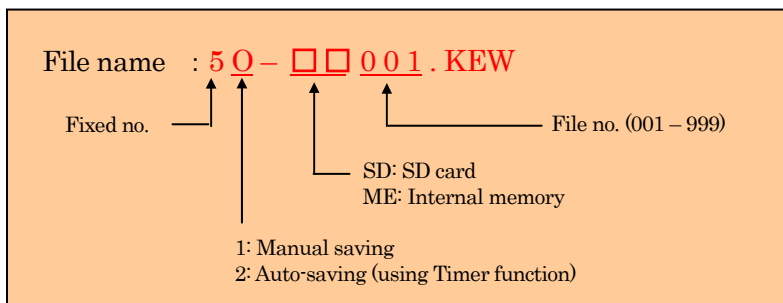

## Data transfer

### 1. SD card and USB

Data in SD card or internal memory can be transferred to PC using USB connection or SD card slot/ reader.

	Method of transfer	
	USB	Card reader
SD card data (file)	✓ *1	✓
Internal memory data (file)	✓	-----

\*1: It is recommended to transfer the data with big size by use of SD card since transfer of such data via USB takes time. (transfer time : approx 320MB/ hour)

- \* As to the manipulation of SD cards, please refer to the instruction manual attached to the card.
- \* In order to save data without any problem, make sure to delete the files other than the data measured with this instrument from the SD card.

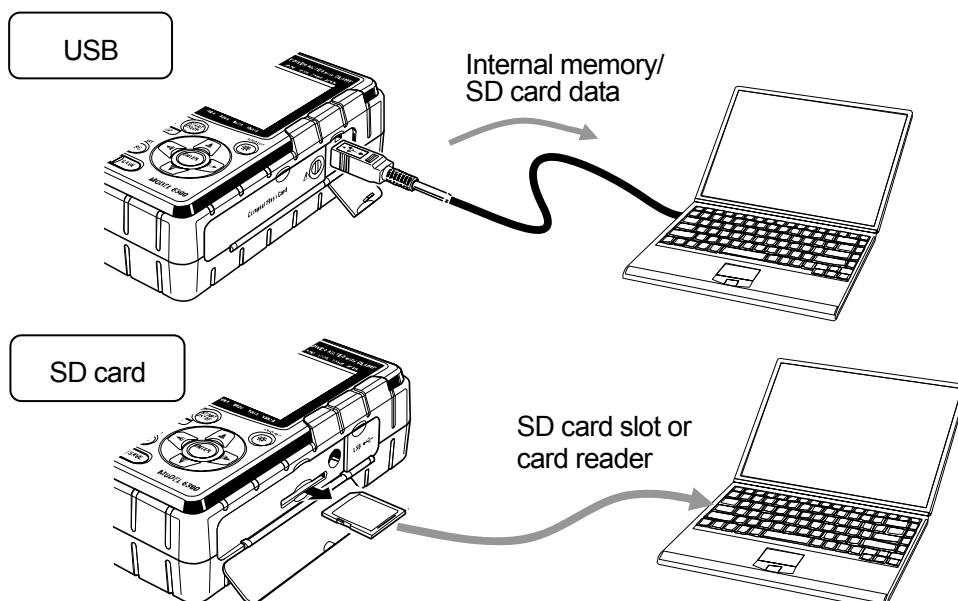

### 2. BLUETOOTH

Measuring data can be checked on android devices in real-time via Bluetooth communication. It is necessary to enable Bluetooth function prior to using Bluetooth communication. (Setting No. 26: Bluetooth)

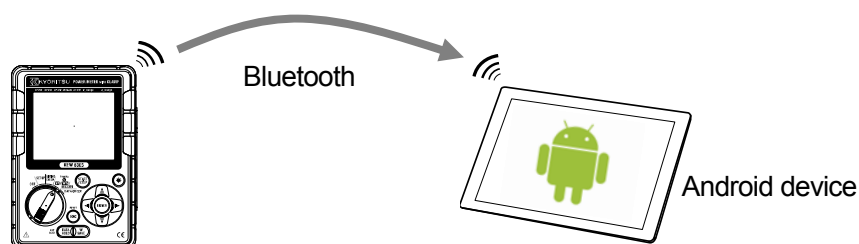

- \* Before starting to use this function, download the special application "KEW Smart" from the Internet site. The application "KEW Smart" is available on download site for free. (An Internet access is required.)

## 9.2 Placing / removing SD card

### △DANGER

- Do not open the SD card Cover during a measurement.

### △WARNING

- Ensure that Voltage test leads and Clamp sensors are removed from the instrument, and that the Function switch is set at the “OFF” position when placing/ removing SD card.

### △CAUTION

- Ensure that the Function switch is set at the “OFF” position when placing/ removing SD card. Otherwise, the stored data may be lost or the instrument may be damaged.

#### ● Inserting SD card:

- (1) Loosen the screw for SD card cover, and open the SD card cover.
- (2) Insert an SD card into SD card slot with the topside turned up.
- (3) Then close the cover and tighten up the screw.

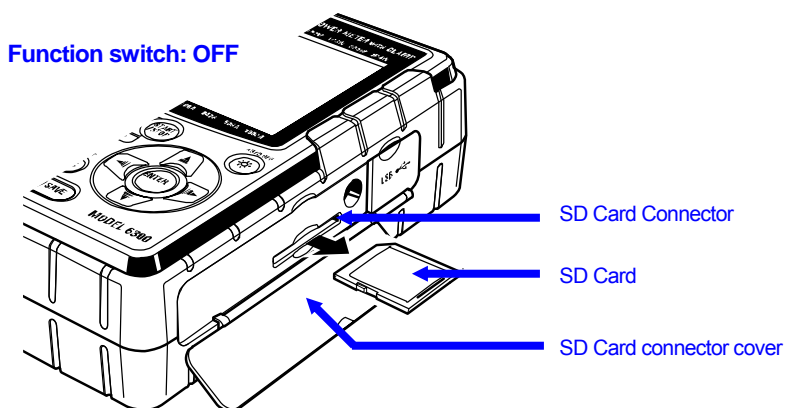

#### ● Removing SD card:

- (1) Loosen the screw for SD card cover, and open the SD card cover.
- (2) Gently push the SD card towards inside, and then the card comes out. Remove the card slowly.
- (3) Close the cover and tighten up the screw.



# 10. Communication function/ Interface software

---

## 1. Introduction

---

### ● Interface

This instrument is equipped with USB and Bluetooth interfaces.

Communication method : USB Ver2.0

Bluetooth : Bluetooth Ver2.1+EDR (Class2)

Compliant profile: SPP

Following can be done by USB/ Bluetooth communication.

\* Downloading files in the internal memory of the instrument to a PC

\* Making settings for the instrument via a PC

\* Displaying the measured results on a PC as graphs in real-time,  
and also saving the measured data at the same time

### ● System Requirements

\* OS(Operation System)

Windows7/Vista/XP (CPU: Pentium 4 1.6GHz or more)

\* Memory

512Mbyte or more (for Windows XP), 1Gbyte or more (for Windows 7/ Vista)

\* Display

1024 × 768 dots, 65536 colors or more

\* HDD (Hard-disk space required)

1Gbyte or more (including Framework)

\*.NET Framework (3.5 or more)

### ● Trademark

\* Windows® is a registered trademark of Microsoft in the United States.

\* Pentium is a registered trademark of Intel in the United States.

\* Bluetooth is a registered trademark of Bluetooth SIG.

The latest software is available for download from our homepage.

<http://www.kew-ltd.co.jp>

---

## 2. Installing the “KEW Windows for KEW6305”

---

- (1) Followings shall be checked before installing the software.
  - \* To prepare your system to install this software, please close all open programs.
  - \* Be sure NOT to connect the instrument with a USB until installation completes.
  - \* Installation shall be done with Administrative right.
- (2) Insert the CD-ROM in your PC's CD-ROM Drive. Click the “Run KEWSetupLauncher2.exe” when the “AutoPlay” pop-up window appears on Windows Vista or Windows 7. If the installer doesn't run automatically, double click the“ KEWLauncher2.exe” in the CD icon. If the User Account Control dialogue box appears, click “Yes (A)” or “Yes (Y)”.
- (3) Read through and understand the License Agreement and click “ I accept....”, and then click“ Next”.

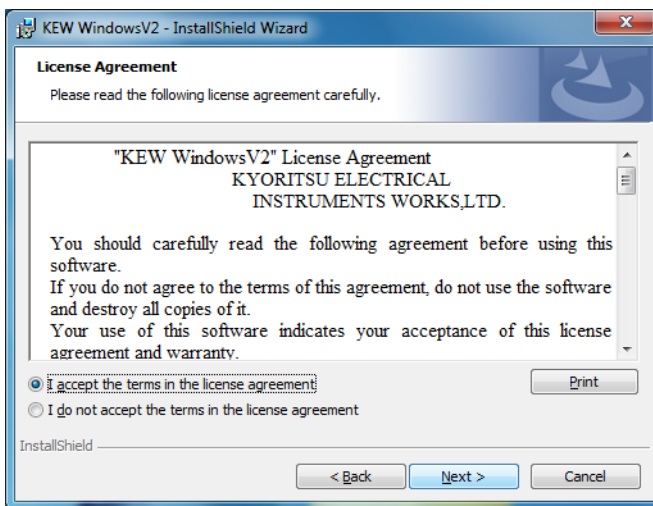

- (4) Click “Next” after entering the user information and other supplementary information.
- (5) Confirm the information on installation, and then click“ Install” to start an installation. If a message requiring restarting your computer is displayed, click “Yes” and restart your computer. Installation process will then restart. Restarting your computer is essential to install the application properly.

(6) Click “Finish” when “InstallShield Wizard Complete” dialogue box appears.

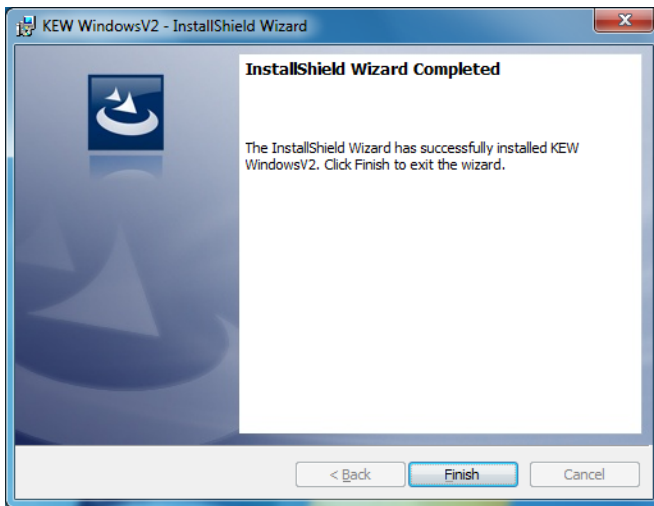

(7) When above installation wizard completes, subsequent installation initiates automatically. If you rebooted your PC at step (5), double click CD drive at My computer to show the following window.

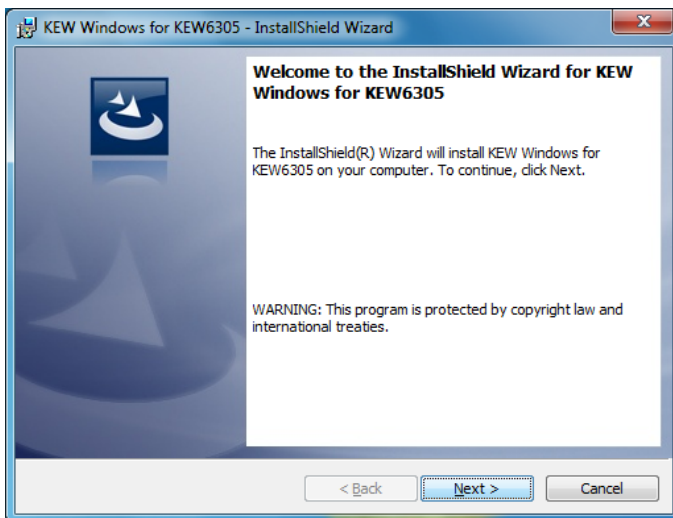

(8) Repeat above step (3) through (6) and completes the installation.

#### **How to un-install the PC Software:**

Access to the “Control Panel” in the Start Menu at the lower left on the Windows screen, and double click on the “Add/ Remove Programs” to remove the “**KEW WindowsV2**” and “**KEW Windows for KEW6305**”.



---

### 3. Installing the USB driver

---

#### **How to install the USB driver (for Windows 7/ Vista)**

- (1) When the KEW Windows for KEW6305 has been successfully installed in your computer, following dialogue box appears to start installing the USB driver. Click “Next”.



- (2) Read through and understand the End User License Agreement and click“ I accept...”, and then click“ Next”.



- (3) If the Security Warning message appears, click on the “Install this driver anyway”.  
(It is no problem to continue installing because operation has already been verified.)

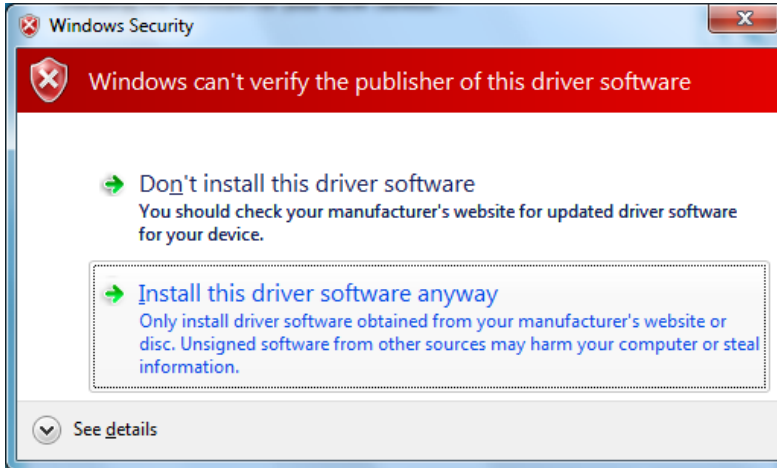

- (4) Installation completes when the following window appears. Click “Finish”.

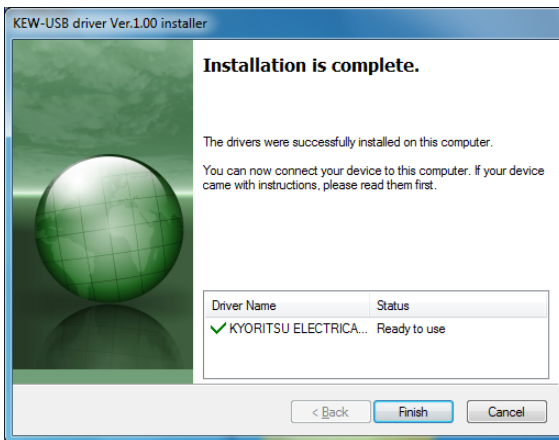

The USB driver been successfully installed. Power on KEW6305 first, and then connect to you PC.

**To restart the interrupted USB driver installation process, right click on the CD drive and click “Open”.**  
**Click and start “kewusb100\_setup.exe” in the “DRIVER” folder.**

## How to install the USB driver (for Windows XP)

- (1) When the KEW Windows for KEW6305 has been successfully installed in your computer, following dialogue box appears to start installing the USB driver. Click “Next”.



- (2) Read through and understand the End User License Agreement and click “ I accept....”, and then click “ Next”.

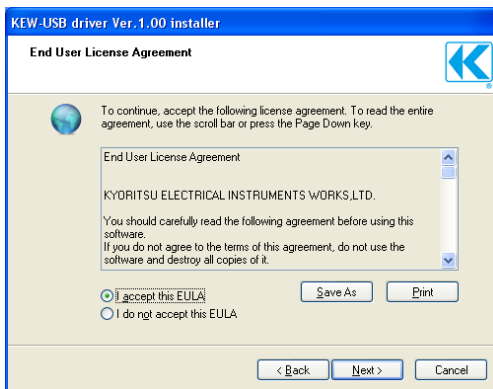

- (3) If the Warning message appears, click “Continue Anyway”. (It is no problem to continue installing because operation has already been verified.)



- (4) Click “Finish” when an “Installation complete” window appears.
- (5) The USB driver has been successfully installed. Power on KEW6305 first, and then connect to you PC.  
The “Found New Hardware Wizard” appears. Click “No, not this time.” and then “Next”.
- (6) On the following window, select “Install the software automatically. (Recommended)” and

click "Next".

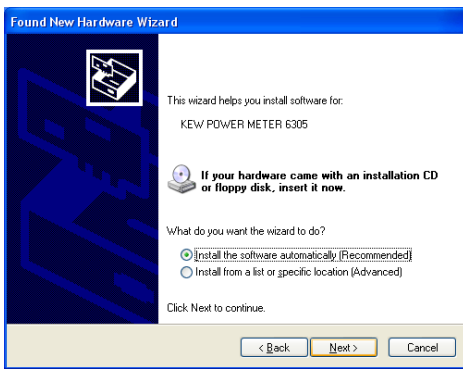

(7) If the Warning message appears, click "Continue Anyway". (It is no problem to continue installing because operation has already been verified.)



(8) When the installation completes, the Completing the Found New Hardware Wizard screen appears. Click "Finish".

**To restart the interrupted USB driver installation process, right click on the CD drive and click "Open".**

**Click and start "kewusb100\_setup.exe" in the "DRIVER" folder.**

## 4. Starting the “KEW Windows for KEW6305”

Click the “KEW WindowsV2” icon on your desktop, or click “Start”-> “Program”-> “KEW”-> “KEW WindowsV2”.

Ensure that KEW6305 gets started before connecting KEW6305 to your PC. Then start KEW WindowsV2.

The main window for “KEW WindowsV2” appears. Select “KEW6305” and click “Start” or double click on the “KEW6305” to get the KEW6305 started. Click “Close” or close button (x) on the right-top to end the program.

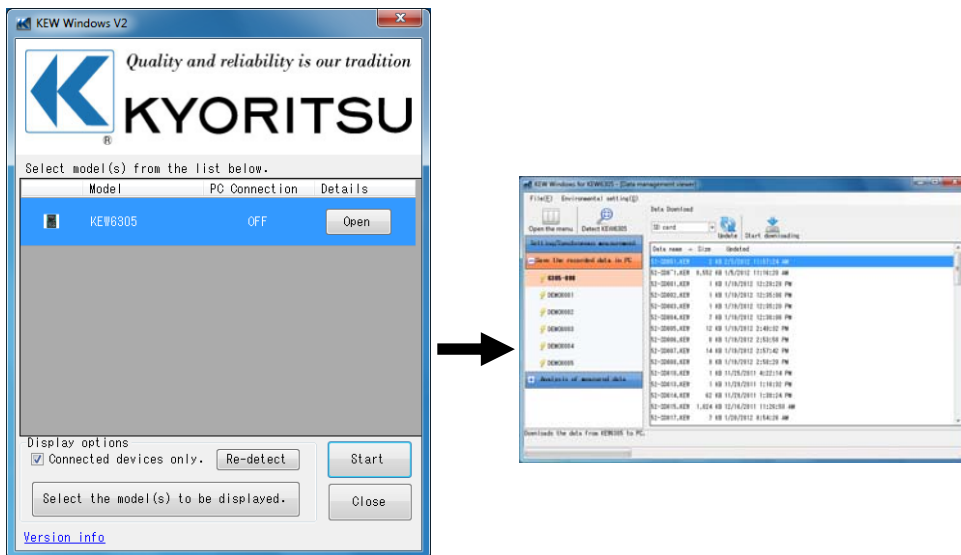

For further instructions, please read the instruction manual. Click (Double click) the desktop shortcut to “KEW Windows for KEW6305 MANUAL”.

# 11. Other functions

## 11.1 Getting power from measured lines

When there is difficulties in getting power from an outlet, KEW6305 operates with powers on the measured line by using Voltage test leads with Power supply adapter MODEL8312.

Connect the Adapter according to following procedure.

- 1 Confirm that the Adapter is off.
- 2 Connect the Plug of the Adapter to VN and V1 terminals on KEW6305 and Power Plug to the Power connector respectively.
- 3 Connect the Voltage test leads to VN and V1 terminals of the Adapter.
- 4 Connect the Alligator clips of the Voltage test leads to the circuit under test.
- 5 Power on the Adapter.
- 6 Power on KEW6305.

\* Reversed procedure is applied to remove the Adapter from KEW6305.

Fuse rating : AC500mA/ 600V,  
Fast acting,  $\Phi 6.3 \times 32\text{mm}$

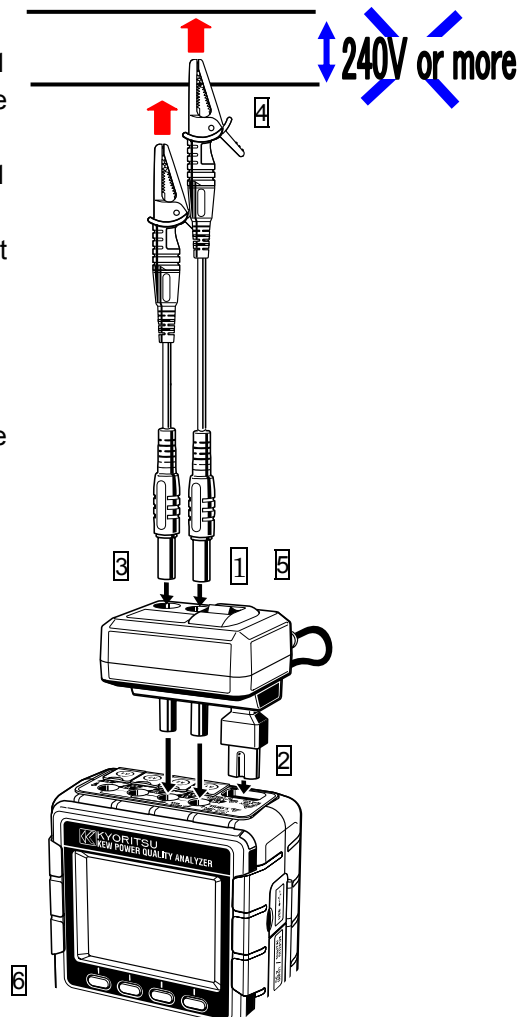

For further details, refer to the Instruction manual for MODEL 8312.

## 11.2 Auto-ranging

Auto-ranging function is available at W, Wh, DEMAND and WAVE Ranges. Current values in wide range can be measured with this function; it is helpful when load capacitances vary dramatically according to day and time.

- Range: 2-range-auto/ max and min range of each Clamp sensor
- Range shift to upper one when crest values equal to twice as much as F.S (sine wave) at min range is detected.

Accurate values may not be obtained when substantial fluctuations in 1 sec.

## 11.3 Operation at AC power interruption

When an AC power supply is interrupted during recording, KEW6310 operates as follows.

- Power supply : restores to battery when batteries have been installed
- Measurement data : saved until the last interval before an interruption
- Operation after interruption : recording restarts with preset settings if a power is interrupted during recording. In this case, occurrence of interruption is recorded with time and date information. (STOP) Restoration is also recorded as well. (START)  
Instrument doesn't power on again automatically when a power interruption occurs and restores other than recording period.

Files in CF card or Internal memory may be destroyed if an AC power is interrupted while accessing to them.

Use of AC power supply and batteries at the same time is recommended if power interruptions are concerned.

## 12. Troubleshooting

When defect or breakdown of the instrument is suspected, check the following points first.  
If your problem isn't listed in this section, contact your local Kyoritsu distributor.

Symptom	Check
(1) Instrument cannot be powered on.	<p><b>operating with an AC power supply</b></p> <ul style="list-style-type: none"> <li>- Power cord is connected firmly and properly?</li> <li>- No break in the Power cord?</li> <li>- Supply voltage is within the allowable range?</li> </ul> <p><b>operating with batteries</b></p> <ul style="list-style-type: none"> <li>- Batteries are installed with observing correct polarity?</li> <li>- Ni-HM batteries are full-charged?</li> <li>- Alkaline batteries are not exhausted?</li> </ul>
(2) Error message appears when powering on the instrument.	<ul style="list-style-type: none"> <li>● Power off the instrument, and power it on again. There is no problem when an error message doesn't appear; the internal circuit may be damaged when the same error message appears. Contact your local Kyoritsu distributor.</li> <li>● In case that NG (Err.001) is found only on RTC item, it means internal coin battery for backup is exhausted. (Date and time may be wrong every time when powering off the instrument) Contact your local Kyoritsu distributor. Backup battery life is approx 5 years.</li> </ul>
(3) Any key doesn't work.	<ul style="list-style-type: none"> <li>● Key lock function is inactivated?</li> <li>● Check the effective Keys on each Range.</li> </ul>
(4) Readings are not stable or inaccurate	<p>Confirm that:</p> <ul style="list-style-type: none"> <li>* Voltage test leads and clamp sensors are connected properly.</li> <li>* Setting for the instrument and the selected wiring configuration are appropriate.</li> <li>* Proper sensors are used with proper settings.</li> <li>* There is no break in the voltage test leads.</li> <li>* Input signal is not interfered.</li> <li>* Strong electric magnetic field does not exist in close proximity.</li> <li>* Use environment meets the specification of this instrument.</li> </ul>
(5) Incapable of saving data to the internal memory	<ul style="list-style-type: none"> <li>● Check the number of files in the memory.</li> <li>● Check that the destination for saving data is set to internal memory.</li> </ul>



Symptom	Check
(6) Data cannot be saved in a CF card.	<ul style="list-style-type: none"> <li>● CF card is inserted correctly?</li> <li>● CF card has been formatted?</li> <li>● Is there available space in a CF card?</li> <li>● Destination for saving data is set to “CF card”?</li> <li>● Check the max number of files or capacity of CF card.</li> <li>● Confirm that the operation of CF card to be used is checked.</li> <li>● Verify the proper operation of CF card on other hardware.</li> </ul>
(7) Download and setting cannot be done via USB communication.	<p>Confirm that:</p> <ul style="list-style-type: none"> <li>* instrument and PC are connected with USB cord correctly,</li> <li>* SET UP Range is selected, and</li> <li>* device are recognized on KEW PQA MASTER. A USB driver may not be installed correctly if no device is recognized. See Section 13.</li> </ul>

# 13.Specification

## 13.1 General specification

Location for use	: In door use, Altitude up to 2000m
Temperature & humidity range (guaranteed accuracy)	: 23°C±5°C, Relative humidity 85% or less (no condensation)
Operating Temperature & humidity range	: 0°C±40°C, Relative humidity 85% or less (no condensation)
Storage Temperature & humidity range	: -20°C±60°C, Relative humidity 85% or less (no condensation)
Measured line	: single-phase 2-wire (1ch ~ 3ch), single-phase 3-wire, three-phase 3-wire, three-phase 4-wire
Insulation resistance	: 50MΩ or more / 1000V between (Voltage/Current input terminal, Power connector) and (Enclosure)
Indication renewal	: every 1 sec
Applicable standards	: IEC61010-1, -2-030 Measurement CAT. III 600V Pollution degree 2, IEC 61010-031, IEC61326
Dimension	: 175(L) x 120(W) x 65(D) mm
Weight	: approx 900g (including batteries)
Accessories	: Voltage test leads M7141B (red/ green/ black, blue w/alligator clip) x 1 set Power cord M7170 x 1 pce Alkaline size AA battery (LR6) x 6 pcs CD-ROM x 1 pce - Communication software (KEW Windows for KEW6305) - Instruction manual (PDF file) USB cable M7148 (with Filter) x 1 pce Carrying case M9125 x 1 pce Quick manual x 1 pce SD card x 1 pce
Optional parts	: SD card 2GB (M-8326-02) M-8128(Clamp sensor 50A Φ24mm) M-8127(Clamp sensor 100A Φ24mm) M-8126(Clamp sensor 200A Φ40mm) M-8125(Clamp sensor 500A Φ40mm) M-8124(Clamp sensor 1000A Φ68mm) M-8129(Flexible sensor 3000A Φ150mm) Power supply adopter M-8312 Carrying case (for instrument) M-9132

## 13.2 Inst measurement ( **W** Range)

### (1) Voltage V(i) [V]

Range	150/ 300/ 600V
Displayed digit	4 digits
Allowable input	10 to 110% of each range
Display range	5 to 130% of each range
Crest factor	2.5 or less
Accuracy	$\pm 0.2\%rdg \pm 0.2\%f.s.$ (sine wave, 45 - 65Hz)
Input impedance	approx. 8.3M $\Omega$

### (2) Current A(i) [A]

Range	50A type (8128) :1/ 5/ 10/ 25/ 50A/ AUTO 100A type(8127) :2/ 10/ 20/ 50/ 100A/ AUTO 200A type(8126) :4/ 20/ 40/ 100/ 200A/ AUTO 500A type(8125) :10/ 50/ 100/ 250/ 500A/ AUTO 1000A type(8124) :50/ 100/ 200/ 500/ 1000A/ AUTO 3000A type(8129) :300/ 1000/ 3000A
Displayed digit	4 digits
Allowable input	10 to 110% of each range
Display range	1 to 130% of each range
Crest factor	3.0 or less (max1.4Vpeak)
Accuracy	$\pm 0.2\%rdg \pm 0.2\%f.s.$ + accuracy of clamp sensor (sine wave, 45 - 65Hz) * +1% f.s. at the lowest range.
Input impedance	approx. 100k $\Omega$

### (3) Active power P(i) [W]

Range	(Voltage range) x (Current range)	
Displayed digit	4 digits	
Accuracy	$\pm 0.3\%rdg \pm 0.2\%f.s.$ + accuracy of clamp sensor (power factor 1, sine wave, 45 - 65Hz) * +1% f.s. when the lowest current ranges is selected.	
Effect of power factor	$\pm 1.0\%rdg$ (indicated value when power factor 0.5 against power factor 1)	
Polarity indication	Consumption : +( no mark), Regeneration: -	
Equation	1P2W	$\times 1$ $P = P_1$
		$\times 2$ $P = P_1 + P_2$
		$\times 3$ $P = P_1 + P_2 + P_3$
	1P3W	$P = P_1 + P_2$
	3P3W	$P = P_1 + P_2$
	3P3W3A	$P = P_1 + P_2 + P_3$
	3P4W	$P = P_1 + P_2 + P_3$

### (4) Frequency f [Hz]

Accuracy	$\pm 3dgt$
Displayed digit	3 digits
Allowable input	10 - 110% of V range (sine wave, 45 - 65Hz)
Display range	40.0 - 70.0Hz
Input source	V1

(5) Calculation items

Apparent power S [VA]

Displayed digit	Same as active power.	
Equation	1P2W	×1 $S = V \times A$
		×2 $S_{-i} = V1 \times Ai(i=1,2), S = S_{-1} + S_{-2}$
		×3 $S_{-i} = V1 \times Ai(i=1,2,3), S = S_{-1} + S_{-2} + S_{-3}$
	1P3W	$Si = Vi \times Ai(i=1,2), S = S1 + S2$
	3P3W	$Si = Vi \times Ai(i=1,2), S = \frac{\sqrt{3}}{2}(S1 + S2)$
	3P3W3A	$Si = Vi \times Ai(i=1,2,3), S = S1 + S2 + S3$
	3P4W	$Si = Vi \times Ai(i=1,2,3), S = S1 + S2 + S3$

Reactive power Q [Var]

Displayed digit	Same as active power.	
Polarity indication	- (minus) : leading phase + (no sign) : lagging phase	
Equation	1P2W	×1 $Q = \sqrt{S^2 - P^2}$
		×2 $Q_{-i} = \sqrt{S_{-i}^2 - P_{-i}^2}(i=1,2),$ $Q = Q_{-1} + Q_{-2}$
		×3 $Q_{-i} = \sqrt{S_{-i}^2 - P_{-i}^2}(i=1,2,3),$ $Q = Q_{-1} + Q_{-2} + Q_{-3}$
	1P3W	$Qi = \sqrt{Si^2 - Pi^2}(i=1,2), Q = Q1 + Q2$
	3P3W	$Qi = \sqrt{Si^2 - Pi^2}(i=1,2), Q = Q1 + Q2$
	3P3W3A	$Qi = \sqrt{Si^2 - Pi^2}(i=1,2,3), Q = Q1 + Q2 + Q3$
	3P4W	$Qi = \sqrt{Si^2 - Pi^2}(i=1,2,3), Q = Q1 + Q2 + Q3$

Power factor PF

Display range	-1.000 to 0.000 to 1.000	
Polarity indication	- (minus) : leading phase + (no sign) : lagging phase	
Equation	1P2W	×1 $PF = \left  \frac{P}{S} \right $
		×2 $PFi = \left  \frac{Pi}{Si} \right (i=1,2), PF = \left  \frac{P}{S} \right $
		×3 $PFi = \left  \frac{Pi}{Si} \right (i=1,2,3), PF = \left  \frac{P}{S} \right $
	1P3W	$PFi = \left  \frac{Pi}{Si} \right (i=1,2), PF = \left  \frac{P}{S} \right $
	3P3W	$PFi = \left  \frac{Pi}{Si} \right (i=1,2), PF = \left  \frac{P}{S} \right $
	3P3W3A	$PFi = \left  \frac{Pi}{Si} \right (i=1,2,3), PF = \left  \frac{P}{S} \right $
	3P4W	$PFi = \left  \frac{Pi}{Si} \right (i=1,2,3), PF = \left  \frac{P}{S} \right $

**Neutral current In [A]** \*only when "WIRING = 3P4W"

Calculation	$An = A1 + A2 \cos\theta_2 + A3 \cos\theta_3$ *θ2 : Phase difference between A1 and A2 *θ3 : Phase difference between A1 and A3
-------------	---

### 13.3 Integration measurement ( **Wh** Range)

Active energy WP [Wh]

Displayed item	Consumption (Overall: + $WP$ , each phase: + $WPi$ )	
Display range	0.00Wh to 999999GWh (digit and unit will be adjusted according to + $WS$ .)	
Equation	Consumption (+WP)	Each phase: + $WPi = \sum \frac{(+ Pi)}{h}$ Overall: + $WP = \sum (+ WPi)$
	Regeneration (-WP)	Each phase: - $WPi = \sum \frac{(- Pi)}{h}$ Overall: - $WP = \sum (- WPi)$

- \*  $h$  : Duration of integration
- \*  $i = 1$  (1P2W\_1ch)
- \*  $i = 1, 2$  (1P2W\_2ch, 1P3W,3P3W)
- \*  $i = 1, 2, 3$  (1P2W\_3ch, 3P3W3A, 3P4W)

Apparent energy WS [VAh]

Displayed item	Consumption (Overall: + $WS$ , each phase: + $WSi$ )	
Display range	0.00VAh to 999999GVAh (digit and unit will be adjusted according to + $WS$ )	
Equation	Consumption (+WS)	Each phase: + $WSi = \sum \frac{(+ Si)}{h}$ Overall: + $WS = \sum (+ WSi)$
	Regeneration (-WS)	Each phase: - $WSi = \sum \frac{(- Si)}{h}$ Overall: - $WS = \sum (- WSi)$

- \* if: +Si:P>0, -Si:P<0
- \*  $h$  : Duration of integration
- \*  $i = 1$  (1P2W\_1ch)
- \*  $i = 1, 2$  (1P2W\_2ch, 1P3W,3P3W)
- \*  $i = 1, 2, 3$  (1P2W\_3ch, 3P3W3A,3P4W)

Reactive energy WQ [Varh]

Displayed item	None (Following data will be saved.)	
Display range	0.00varh ~ 999999Gvarh	
Equation	Consumption (+WQ)	Overall: + $WQ = \sqrt{(+WS)^2 - (+WP)^2}$

Duration of integration	
Displayed item	00:00:00 (hour: minute: second)
Display range	00:00:00 (0 sec.) - 99:59:59 (99-hour 59-min 59-sec) to 000100 - 999999 (999999-hour) *Display changes as above.

## 13.4 Demand measurement ( **DEMAND** Range)

### (1) Target value (T<sub>DEM</sub>)

Display range	Preset value will be displayed and not vary. (0.1W - 999.9GW)
---------------	---

### (2) Predicted value (G<sub>DEM</sub>)

Display range	Decimal position and unit are the same as T <sub>DEM</sub> . 0 to 999999dgt ("OL" will be displayed if exceeding this range.)
Equation	$G_{DEM} = \Sigma DEM \times \frac{\text{Demand interval}}{\text{Period from beginning of demand interval}}$

### (3) Demand value (present value) (ΣDEM)

Display range	Decimal position and unit are the same as T <sub>DEM</sub> . 0 to 999999dgt ("OL" will be displayed if exceeding this range.)
Equation	$\Sigma DEM = (+WP \text{ from beginning of demand interval}) \times \frac{1 \text{ hour}}{\text{Demand interval}}$ , if $\Sigma DEM = \sum \Sigma DEM_i$

- $i = 1$  (1P2W×1)
- $i = 2$  (1P2W×2, 1P3W, 3P3W)
- $i = 3$  (1P2W×3, 3P3W3A, 3P4W)

### (4) Load factor

Display range	0.00 to 9999.99% ("OL" will be displayed if exceeding this range.)
Equation	$\frac{\Sigma DEM}{T_{DEM}}$

## 13.5 Other specifications



### (1) AC power supply

Voltage range	AC100~240V±10%
Frequency	45~65Hz
Power consumption	10VA max

### (2) DC power supply

Type	LR6: size AA (alkaline) battery x 6 pcs
Rated voltage	DC9V (=1.5V×6)
Current consumption	110mA typ.(@9V)
Battery life	approx. 15 hours (standard use, Bluetooth: OFF, Backlight: OFF)

(4) Battery check function

Power supply		Mark	Battery voltage [V] ( $\pm 0.1V$ )
AC power supply			—
DC power supply (battery)	Effective range		10.5 ~ 5.5V
	Warning	 ( blink)	5.5V or less

\* KEW6305 operates with an AC power supply if it is connected to.

(5) Recording data

Internal memory

Memory	FLASH memory
Recording capacity	3MB
Data capacity	1352byte/ data (11200 results / manual saving, 2200 results: auto-saving(timer))
Max number of saved file	4

PC Card

Card type	SD memory card (SD card)
Capacity	2GB
Data capacity	1352byte/data
Max number of saved results	Manual saving (1GB: approx. 3.74 million), (2GB: approx. 7.49 million) Auto-saving (1GB: approx. 730 thousand), (2GB: approx. 1.47 million) Max file size per file is 2GB.
Max number of saved file	Max 511 files
Save format	KEW format
Format	2GB or less: FAT16, 4GB or more: FAT32

(6) External communication function

Communication method	USB Ver2.0
USB identification no.	Vendor ID:12EC(Hex) Product ID:6305(Hex) Serial no.:0+7 digit individual no
Communication speed Baud rate	12Mbps (Full speed)

\* Daisy chain of multiple units of KEW6305 (10pcs. max) using HUB makes individual-recognition possible.



(Data transfer to PC can be done one unit each.)

\* USB cable length: 2m max.



(7) External communication function (Bluetooth)

Communication method	BluetoothVer2.1+EDR(Class2)
Profile.	SPP
Frequency	2402 ~ 2480MHz
Modulation method	GFSK(1Mbps), $\pi/4$ -DQPSK(2Mbps), 8DPSK(3Mbps)
Transmission system:	Frequency-hopping system

### 13.6 Specification of Clamp sensor

	< MODEL8128 >	< MODEL8127 >	< MODEL8126 >
			
Rated current	AC 5Arms (max rating: AC50Arms)	AC 100Arms (141Apeak)	AC 200Arms (283Apeak)
Output voltage	0 ~ 50Arms (AC 50mV/AC 5A) (AC 500mV/AC50A)	AC0 ~ 500mV (AC500mV/AC100A) : 5mV/A	AC0 ~ 500mV (AC 500mV/AC200A) : 2.5mV/A
Measuring range	AC0 ~ 50Arms(70.7Apeak)	AC0 ~ 100A	AC0 ~ 200A
Accuracy (sine input)	±0.5%rdg±0.1mV (50/60Hz) ±1.0%rdg±0.2mV (40Hz ~ 1kHz)		
Phase characteristics	within ±2.0° (0.5 ~ 50A/ 45 ~ 65Hz)	within ±2.0° (1 ~ 100A/ 45 ~ 65Hz)	within ±1.0° (2 ~ 200A/ 45 ~ 65Hz)
Temp. & humidity range (guaranteed accuracy)	23±5°C, relative humidity 85% or less (no condensation)		
Operating temp. range	0 ~ 50°C, relative humidity 85% or less (no condensation)		
Storage temp. range	-20 ~ 60°C, relative humidity 85% or less (no condensation)		
Allowable input	AC50Arms (50/60Hz)	AC100Arms (50/60Hz)	AC200Arms (50/60Hz)
Output impedance	approx 20Ω	approx 10Ω	approx 5Ω
Location for use	indoor use, altitude 2000m or less		
Applicable standard	IEC 61010-1, IEC 61010-2-032 Measurement CAT.III (300V) Pollution degree 2 IEC61326		IEC 61010-1, IEC 61010-2-032 Measurement CAT.III (600V) Pollution degree 2 IEC61326
Withstand voltage	AC3540V/ 5 sec between Jaws – enclosure, enclosure – output terminal, Jaws – output terminal	AC3540V/ 5 sec between Jaws – enclosure, enclosure – output terminal, Jaws – output terminal	AC5350V/ 5 sec between Jaws – enclosure, enclosure – output terminal, Jaws – output terminal
Insulation resistance	50MΩ or more/ 1000V between Jaws – enclosure, enclosure – output terminal, Jaws – output terminal		
Max conductor size	Φ24mm		Φ40mm
Dimension	100(L) × 60(W) × 26(D)mm		128(L) × 81(W) × 36(D)mm
Cable length	approx 3m		
Output terminal	MINI DIN 6PIN		
Weight	approx 160g		approx 260g
Accessory	Instruction manual, Cable marker		
Option	7146 (Φ4 Banana plug), 7185 (Extension lead)		



< MODEL8125 >	< MODEL8124 >	< KEW8129 >
		
AC 500Arms (707Apeak)	AC 1000Arms (1414Apeak)	AC 300/1000/3000 Arms
AC0 ~ 500mV (AC500mV/500A) : AC 1mV/A	AC0 ~ 500mV (AC500mV/1000A) : 0.5mV/A	300A Range : AC500mV/AC300A(1.67mV/A) 1000A Range : AC500mV/AC1000A(0.5mV/A) 3000A Range : AC500mV/AC3000A(0.167mV/A)
AC0 ~ 500Arms	AC0 ~ 1000Arms	300A Range : 30 ~ 300Arms (424Apeak) 1000A Range 100 ~ 1000Arms (1414Apeak) 3000A Range : 300 ~ 3000Arms(4243Apeak)
±0.5%rdg±0.1mV (50/60Hz) ±1.0%rdg±0.2mV (40Hz ~ 1kHz)	±0.5%rdg±0.2mV (50/60Hz) ±1.5%rdg±0.4mV (40Hz ~ 1kHz)	±1.0%rdg (45 ~ 65Hz) (at the center of sensor)
within ±1.0° (5 ~ 500A/ 45 ~ 65Hz)	within ±1.0° (10 ~ 1000A/ 45 ~ 65Hz)	within ±1.0° (within the measuring range of each Range at frequency of 45 ~ 65Hz)
23±5°C, relative humidity 85% or less (no condensation)		
0 ~ 50°C, relative humidity 85% or less (no condensation)		
-20 ~ 60°C, relative humidity 85% or less (no condensation)		
AC500Arms (50/60Hz) approx 2Ω	AC1000Arms (50/60Hz) approx 1Ω	AC3600Arms (50/60Hz) approx 100Ω or less
indoor use, altitude 2000m or less		
IEC 61010-1, IEC 61010-2-032 Measurement CAT.III (600V), Pollution degree 2 IEC61326		
AC5350V/ 5 sec between Jaws – enclosure, enclosure – output terminal, Jaws – output terminal		AC5350V/ 5 sec between circuit – sensor
50MΩ or more/ 1000V between Jaws – enclosure, enclosure – output terminal, Jaws – output terminal		50MΩ or more/ 1000V between circuit – sensor
Φ40mm	Φ68mm	Φ150mm
128(L) × 81(W) × 36(D)mm	186(L) × 129(W) × 53(D)mm	111(L) × 61(W) × 4 3(D)mm (protrusions are not included)
approx 3m		Sensor part : approx 2m Output cable : approx 1m
MINI DIN 6PIN		
approx 260g	approx 510g	8129-1 : approx410g 8129-2 : approx680g 8129-3 : approx950g
Instruction manual, Cable marker		Instruction manual, Output cable (M-7199) Carrying case
7146 (Φ4 Banana plug), 7185 (Extension lead)		

## DISTRIBUTOR

Kyoritsu reserves the rights to change specifications or designs described in this manual without notice and without obligations.



## **KYORITSU ELECTRICAL INSTRUMENTS WORKS, LTD.**

2-5-20, Nakane, Meguro-ku,  
Tokyo, 152-0031 Japan

Phone: +81-3-3723-0131

Fax: +81-3-3723-0152

URL: <http://www.kew-ltd.co.jp>

E-mail: [info-eng@kew-ltd.co.jp](mailto:info-eng@kew-ltd.co.jp)

Factory: Ehime, Japan