

INSTRUCTION MANUAL

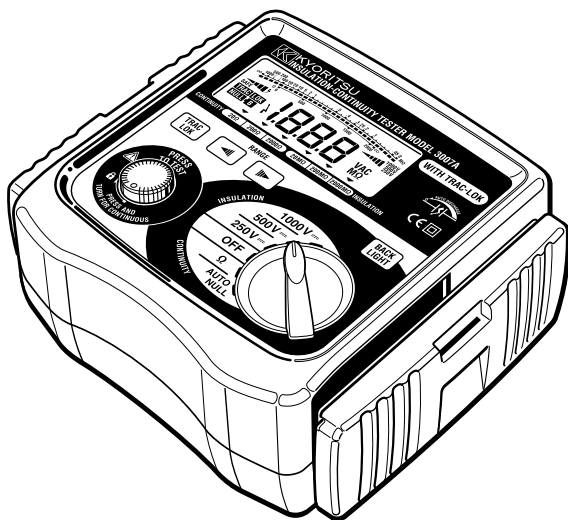

DIGITAL INSULATION-CONTINUITY TESTER

MODEL 3005A / 3007A

KYORITSU ELECTRICAL INSTRUMENTS
WORKS, LTD.

CONTENTS

1. SAFETY PRECAUTIONS	1
2. FEATURES	4
3. SPECIFICATIONS	5
4. INSTRUMENT LAYOUT	9
4-1 Instrument layout	9
4-2 LCD	10
4-3 Connector	11
5. PREPARATION FOR MEASUREMENT	12
5-1 Removing the Cover	12
5-2 Battery Voltage Check	12
5-3 Test Probe Connection	12
6. OPERATION	13
6-1 Disconnection and Check of Power Source of the Circuit under Test	13
6-2 Insulation Resistance Measurement	14
6-3 Continuity Measurement (Resistance Tests)	16
6-4 Continuous Measurement	17
7. FUNCTIONS	18
7-1 TRAC-LOK Mode (Model 3007A only)	18
7-2 AUTO NULL	18
7-3 Back Light (Model 3007A only)	18
7-4 Auto Power Off	18
8. BATTERY & FUSE REPLACEMENT	19
8-1 Battery Replacement	19
8-2 Fuse Replacement	19
9. CASE AND STRAP BELT ASSEMBLY.....	20
10. CLEANING OF THE INSTRUMENT	21
11. SERVICING.....	21

1. SAFTY PRECAUTIONS

The instrument is designed to produce in accordance with the following standards and supplied in the best conditions after successfully clearing the inspection.

- IEC 61010-1 Overvoltage CAT III 300V Pollution Degree 2
- IEC 61010-2-31 (Safety requirements for hand-held probe assemblies)

This instruction manual describes warnings and safety rules which must be observed by the user to ensure safety operation of the instrument and to retain it in safe condition. Therefore, read through these instructions before using the instrument.

WARNING



Read through and understand instructions contained in this manual before using the instrument.

Save and keep the manual handy to enable quick reference whenever necessary.

The instrument must only be used by a competent trained person and operated in strict accordance with the instructions. KYORITSU will not accept any liability for any damage or injury caused by misuse or non-compliance with the instructions or safety procedures.

It is essential to understand the safety rules contained in the manual. They must be observed on using the instrument.

Be sure to observe the above rules strictly. Not following the instructions may cause injury or instrument damage.

The symbol  on the instrument means that the user must refer to the relevant section of this manual for safe operation of the instrument. There are three kinds of the symbol . Read the following instructions of each symbol carefully.

⚠ DANGER is reserved for conditions and actions that are likely to cause serious or fatal injury.

⚠ WARNING is reserved for conditions and actions that can cause serious or fatal injury.

⚠ CAUTION is reserved for conditions and actions that can cause minor injury or instrument damage.

⚠ DANGER

Do not use this instrument on energized (LIVE) circuits.

Do not take measurement in the presence of flammable gasses.

Otherwise, the use of the instrument may cause sparking, which leads to an explosion.

Always keep your fingers behind the barrier on test probe during measurement.

Never use the instrument if its surface or your hand is wet.

Never open the battery compartment cover while taking measurement.

⚠ WARNING

Do not attempt to take any measurements, if any abnormal conditions occur, such as broken test probe and cracked enclosure of the instrument.

Never change function switches with test probe connected to the equipment under test.

Do not install substitute parts, perform any unauthorized modification, or disassemble the instrument. Return the instrument to Kyoritsu or your distributor for service and repair so as to ensure the safety features are maintained.

Do not replace batteries when the surface of the instrument is wet.

Make sure to disconnect the test probe from the instrument before opening the battery compartment cover for battery replacement.

⚠ CAUTION

Always make sure to set the function switch or range selector switch to the appropriate position before taking measurements.

Do not expose the instrument to the direct sun, dew fall or extreme temperature and/or humidity.

When the instrument will not be in use for a long period of time, place it in storage after removing batteries.

Use a damp cloth soaked in water or neutral detergent for cleaning the instrument. Do not use abrasives or solvents.

2. FEATURES

MODEL-3005A/3007A are microprocessor controlled insulation-continuity testers.

Designed to safety standards:

IEC 61010-1 Overvoltage CAT III 300V Pollution Degree 2

IEC 61010-2-31 (Safety requirements for hand-held probe assemblies)

Display with back light function to facilitate work at night or dimly lit locations (Model 3007A only)

Bar graph to indicate measured results

Strap belt to make both hands' operation easier

Live circuit warning indication and buzzer

Auto discharge function

When insulation resistance is measured, electric charges stored in capacitive circuits are automatically discharged after testing. Discharge can be checked with live circuit warning.

Auto power off function

To prevent the instrument from being left powered on and conserve battery power, the instrument automatically turns off approx. 10 minutes after the last switch operation.

LOK mode (Model 3007A only)

The test current is removed once a stable reading is reached to prevent unnecessary battery consumption.

3. SPECIFICATIONS

Measuring Range and Accuracy (at $23 \pm 5^\circ\text{C}$, relative humidity 45 -75%)

Insulation Resistance Ranges:

Nominal Output Voltage		250V	500V	1000V
Measuring Ranges		0 ~19.99M Ω	0 ~19.99M Ω	0 ~19.99M Ω
		0 ~ 199.9M Ω	0 ~ 199.9M Ω	0 ~ 199.9M Ω
		0 ~ 1999M Ω	0 ~ 1999M Ω	0 ~ 1999M Ω
Open-Circuit Voltage		250V DC +20%,-0%	500V DC +20%,-0%	1000V DC +20%,-0%
Nominal Current		1mA DC min. at 0.25M Ω	1mA DC min. at 0.5M Ω	1mA DC min. at 1M Ω
Short-Circuit Current		1.5mA approx		
Accuracy	20M Ω	$\pm 1.5\%rdg \pm 5dgt$		
	200M Ω			
	2000 M Ω	$\pm 10\%rdg \pm 3dgt$	$\pm 3\%rdg \pm 3dgt$	
	0~1G Ω			
	1G~2G Ω			

Continuity Ranges:

Ranges	20 Ω	200 Ω	2000 Ω
Measuring Ranges	0 ~ 19.99 Ω	0 ~ 199.9 Ω	0 ~ 1999 Ω
Open-Circuit Voltage	7 ~ 12V approx		
Measuring Current at 0.2 Ω ~ 2 Ω	200mA min		
Accuracy	$\pm 1.5\%rdg \pm 5dgt$	$\pm 1.5\%rdg \pm 3dgt$	

AC Voltage Indication

0 ~ 600V $\pm 5\%rdg \pm 3dgt$

Typical Number of Measurements.

(central tendency for supply voltage up to 8V)

Insulation Resistance Ranges:

Approx. 1000 times min. at load 0.5M Ω

Continuity Ranges:

Approx. 700 times min. at load 1 Ω

Operating Errors (IEC 61557-2,-4)

Functions	Range	Measuring range to keep operating error	Maximum percentage operating error
1000V	20M Ω	0.50 ~ 19.99M Ω	$\pm 30\%$
	200M Ω	1.0 ~ 199.9M Ω	
	2000M Ω	10 ~ 1000M Ω	
500V	20M Ω	0.50 ~ 19.99M Ω	
	200M Ω	1.0 ~ 199.9M Ω	
	2000M Ω	10 ~ 100M Ω	
250V	20M Ω	0.25 ~ 19.99M Ω	
	200M Ω	1.0 ~ 199.9M Ω	
	2000M Ω	10 ~ 100M Ω	
Ω	20 Ω	0.20 ~ 19.99 Ω	
	200 Ω	1.0 ~ 199.9 Ω	
	2000 Ω	10 ~ 1999 Ω	

The influencing variations used for calculating the operating error are denoted as follows;

Temperature: 0 and 35

Supply voltage : 8V to 13.8V

Applicable Standards

IEC 61010-1 Over voltage CAT III 300V Pollution Degree 2

IEC 61010-2-31 Safety requirements for hand-held probe assemblies

IEC 61557-1/2/4 Measuring equipment for low voltage distribution systems

IEC 61326-1 EMC

IEC 60529 (IP54)	Dust & drip proof
Operating System:	Dual integration
Display:	Liquid crystal display (maximum count: 1999), Unit, Mark Bar graph 30 points max. (20 points on Ω range)
Over range Indication:	"OL" is shown on the display.
Sample Rate:	Approx. 0.5 ~ 2.5 times per second
Operating Temperature & Humidity:	0 ~ +40°C, relative humidity up to 85%
Storage Temperature & Humidity:	-20 ~ +60°C, relative humidity up to 75%
Insulation Resistance:	More than 50M Ω at 1000V DC between electrical circuit and housing case
Withstand Voltage:	3700V AC for one minute between electrical circuit and housing case

Overload Protection

Insulation resistance ranges:

1000V Range	1200V (DC+AC p-p) for 10 seconds
500V Range	600V (DC+AC p-p) for 10 seconds
250V Range	300V (DC+AC p-p) for 10 seconds

Continuity ranges:

20/200/2000 Ω Range	280V (DC+AC p-p) for 10 seconds (Protection by fusing)
-------------------------------	---

Dimensions: 185(L) x 167(W) x 89(D) mm approx.

Weight: 990g approx. (including batteries)

Power Source: 8 x R6P, 1.5V AA or equivalent

Auto-power-off Function: Automatically turns off approx. 10 minutes after the last switch operation.

Consumption current: approx. 75 μ A

Accessories

Test Probe MODEL7122	x 1 set
Strap belt	x 1
Test probe pouch	x 1
Batteries (R6P)	x 8
Instruction manual	x 1
Spare fuse F600V/500mA	x 1

4. INSTRUMENT LAYOUT

4-1 INSTRUMENT LAYOUT

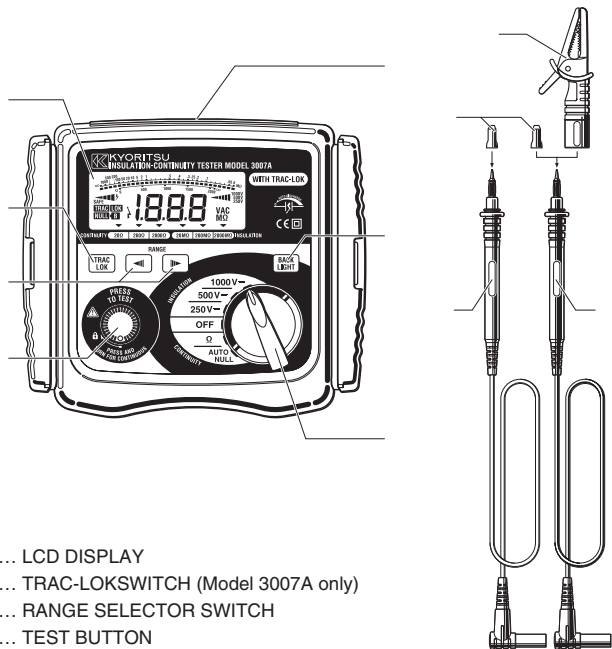

- ... LCD DISPLAY
- ... TRAC-LOKSWITCH (Model 3007A only)
- ... RANGE SELECTOR SWITCH
- ... TEST BUTTON
- ... CONNECTOR
- ... BACK LIGHT SWITCH (Model 3007A only)
- ... FUNCTION SWITCH
- ... TEST PROBE (RED)
- ... TEST PROBE (BLACK)
- ... ALLIGATOR CLIP (BLACK)
- ... PLOBE CAP (BLACK & RED)

4-2 LCD DISPLAY

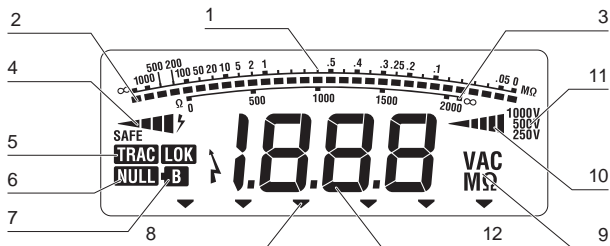

1... INSULATION RESISTANCE SCALE

2... BAR GRAPH

3... CONTINUITY SCALE

4... LIVE CIRCUIT WARNING

	AC LIVE CIRCUIT WARNING	DISCHARGE VOLTAGE
SAFE	0 ~ 2V	0 ~ 2V
▶ ⚡	3 ~ 30V	3 ~ 60V
▶▶ ⚡	31 ~ 60V	61 ~ 120V
▶▶▶ ⚡	61 ~ 120V	121 ~ 240V
▶▶▶▶ ⚡	120V over	240V over

5... TRACK/LOK MODE





6... AUTONULL OPERATION

7... BATTERY VOLTAGE WARNING

8... CONTINUITY/INSULATION RESISTANCE RANGE SETTING

9... UNIT

10...OUTPUT VOLTAGE GRAPH (INSULATION RESISTANCE)

	FUNCTION SETTING PER RATED OUTPUT VOLTAGE
	1 ~ 24%
	25 ~ 49%
	50 ~ 74%
	75 ~ 99%
	100% or over

11... OUTPUT VOLTAGE RANGE

12... MEASUREMENT VALUES

4-3 Connector

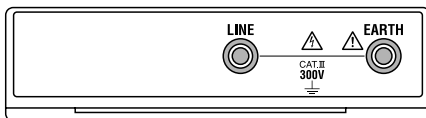

5. PREPARATION FOR MEASUREMENT

5-1 Removing the Cover

Model 3005A/3007A have a dedicated cover to protect against an impact from the outside and prevent the operation part, LCD, and connector socket from becoming dirty. The cover can be detached and put on the back side of the main body during measurement.

Method of removing the cover

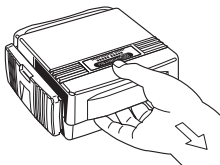

Method of storing the cover

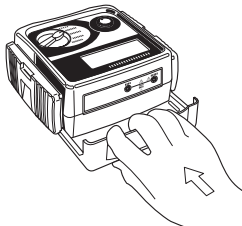

5-2 Battery Voltage Check

Set the function switch to any position except "OFF".

When the battery voltage warning symbol () is lit, the batteries are exhausted. Replace all of them with new ones according to **section 8 for battery & fuse replacement**.

5-3 Test Probe Connection

Insert test probes fully into connector terminals of the instrument.

Connect test probe (black) to EARTH terminal and test probe (red) to LINE terminal of connector terminal.

6. OPERATION

6-1 Disconnection and check of power source of the circuit under test

⚠ DANGER

To avoid possible electrical shock, do not perform measurements on energized (LIVE) circuits.

Never make measurements with the battery compartment cover removed.

⚠ CAUTION

Never press the test button if the live circuit warning is indicated or the warning buzzer sounds. This may damage the circuit.

Voltage check can be made with the function switch at any position except "OFF".

Be sure to turn off the breaker for the circuit under test.

Connect the test probe (black) to the earth side and the test probe (red) to the line side of the circuit under test.

Ensure that the live circuit warning is not lit and the audible warning is not present. When the live circuit warning is lit and the buzzer sounds, never press the test button. Voltage is generated in the circuit under test. Recheck that the breaker for the circuit under test is "OFF".

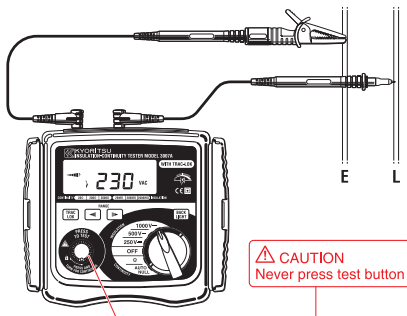

6-2 Insulation Resistance Measurement

DANGER

Always test the circuit or equipment to ensure it is surely de-energized before measurement according to the instruction of 6-1.

To avoid electrical shock, measurements must be performed on de-energized circuits only.

When the test button is pressed with the function switch in the $M\Omega$ position, take care not to touch the tip of the test probe and the circuit under test where a high voltage is present in order to avoid possible shock hazard.

Never make measurement with the battery compartment cover removed.

CAUTION

Never press the test button if the live circuit warning is indicated or the warning buzzer sounds. This may damage the circuit.

Conduct the voltage warning check before measurement to ensure that the circuit under test is de-energized.

Check the voltage which can be applied to the circuit under test and set the function switch and the range selector switch to the desired range.

Connect the test probe (black) to the earth terminal of the circuit under test.

Put the tip of the test probe (red) to the circuit under test and press the test button.

The buzzer sounds intermittently during measurement.

Current outputs from the earth terminal, and returns to the line terminal.

Read the resistance value from the LCD.

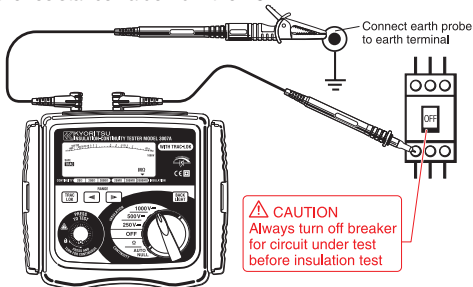

With the test probe still connected to the circuit under test, release the test button to discharge capacitance in the circuit after measurement.

⚠ DANGER

Do not touch the circuit under test immediately after testing. Capacitance stored in the circuit may cause electric shock.

Leave test probes connected to the circuit and never touch the circuit until the discharge is completed.

Principle of Insulation Resistance Measurement

Resistance value can be obtained by applying a certain high voltage to the resistance (insulation resistance) and measuring the flowing current.

$$\text{Resistance Value} = \text{Voltage} / \text{Current}$$

$$RX = V / I$$

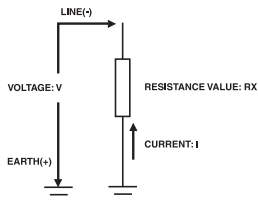

Terminal connection of insulation resistance test

In case of testing insulation of insulated wire and cable against the earth at direct current, connecting - pole of power to cable conductor, + to the earth obtains smaller measuring value, compared with connecting the other way round. This connecting method is generally acknowledged relevant to detect defective insulation.

6-3 Continuity Measurement (Resistance Tests)

DANGER

Always test the circuit or equipment to ensure it is surely de-energized before measurement according to the instruction of 6-1.

To avoid electrical shock, measurements must be performed on de-energized circuits only.

Never make measurement with the battery compartment cover removed.

CAUTION

Never press the test button if the live circuit warning is indicated or the warning buzzer sounds. This may damage the circuit.

When an additional circuit is connected in parallel with the circuit under test, inaccurate reading may be taken.

Set the function switch to the "AUTO NULL" position.

Short the test probes (red) and (black) and press the test button. Then the resistance of the test probes is displayed and memorized with microprocessor.

Set the function switch to "Ω" position.

Connect the test probes to the circuit under test and press the test button.

Read the resistance value from the LCD.

NULL symbol (**NULL**) is displayed while AUTO NULL function is working.

AUTO NULL will be cancelled when the instrument is powered off.

Principle of Continuity Measurement (Resistance Test)

Resistance value can be obtained by applying a certain current to the resistance under test and measuring the voltage generated on the both sides of the resistor under test.

Resistance value = Voltage / Current

$$RX = V / I$$

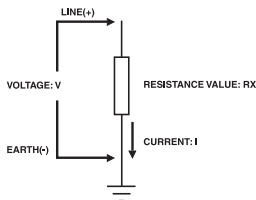

6-4 Continuous Measurement

A lock down feature is incorporated on the test button. Pressing and turning it clockwise, lock the test button in the continuous operating position.

To release the lock, turn the test button counterclockwise.

NOTE:

Model 3007A has TRAC/LOK function. When "LOK" mode is selected, sampling is conducted only once, even though the test button is locked down for continuous measurement.

To make continuous measurement, select "TRAC" mode.

⚠ DANGER

Be extremely careful not to get electric shock during insulation resistance measurement as high voltage is present on the tip of test probes continuously.

7. FUNCTIONS

7-1 TRAC-LOK MODE (Model 3007A)

TRAC mode : Measurement can be conducted while the test button is being pressed.

When making continuous measurement, select this mode.

LOK mode : When the test button is pressed, measurement can be conducted only once, and output is stopped, then automatically discharged.

This allows to economize on the battery life.

7-2 AUTO NULL

When conducting continuity tests, the contact resistance of test probes etc. is automatically subtracted before the real resistance is displayed to obtain more accurate reading.

This function is invalid when the contact resistance, etc. is 10Ω or more.

- NULL symbol (**NULL**) is displayed while AUTO NULL function is working.
- AUTO NULL will be cancelled when the instrument is powered off.

7-3 BACK LIGHT (Model 3007A)

Use BACK LIGHT to facilitate working at night or dimly lit situations.

When the back light switch is pressed with the function switch in any position except "OFF", the back light continues illuminating for approx. 40 seconds and then turns off automatically.

When the back light switch is pressed again, the BACK LIGHT will turn off even within the lighting time.

Press the back light switch while it is on, the light gets brighter. Press it again to turn it OFF.

7-4 AUTO-POWER-OFF

The instrument automatically turns off approx. 10 minutes after the last switch operation. To return to the normal mode, turn the function switch off, then to the desired position.

CAUTION

Slight current is still consumed even after the instrument was powered off by auto-power-off function. Turn the function switch to the "OFF" position when not using the instrument.

8. BATTERY & FUSE REPLACEMENT

⚠ DANGER

Never open the battery compartment cover while making measurement.
To avoid possible electrical shock, disconnect the test probe before opening the cover for battery and fuse replacement.
Replacement fuse must be have the following rating.

Fast acting type, F 500mA/600V, 6.35 x 32mm

8-1 Battery Replacement

Disconnect test probes from the instrument.

Open the battery compartment cover by unscrewing the metal captive screw to reveal battery compartment. Always replace all eight batteries with new ones at the same time.

Battery type: 8 x R6P, 1.5V AA or equivalent

8-2 Fuse Replacement

Disconnect the test probe from the instrument.

Open the battery compartment cover by unscrewing the metal captive screw to reveal battery compartment and replace the fuse.

Fuse type: 600V/500mA (F) quick acting ceramic fuse 6.35 x 32mm

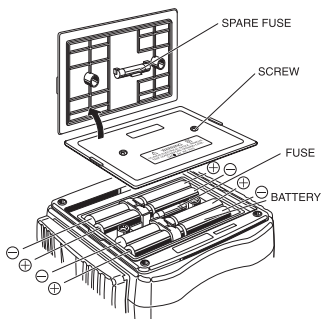

⚠ CAUTION

Install batteries in correct polarity as marked inside.

9. CASE AND STRAP BELT ASSEMBLY

By hanging the instrument around the neck, both hands can be used freely for easy and safety working.

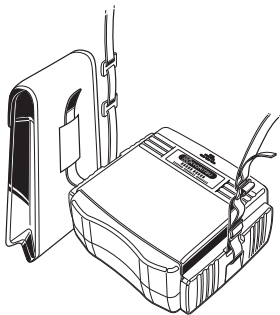

Pass the strap belt down through the side panel of the main body from the top, and up through the slots of the probe case from the bottom.

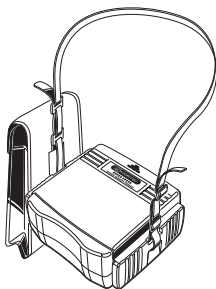

Pass the strap through the buckle, adjust the strap for length and secure.

10. CLEANING OF THE INSTRUMENT

When cleaning the instrument, wipe it with a silicon cloth or soft cloth to remove dust or dirt.

When it is hard to remove the dirt, wipe it with a cloth wet with water and dry the instrument completely after cleaning.

⚠ CAUTION

Never use any solvent which may transmute plastics, for example, organic solvent such as benzene, acetone, etc.

11. SERVICING

If this tester should fail to operate correctly, return it to your nearest distributors stating the exact nature of the fault.

Before returning the instrument, make sure that:

- a) Operating instructions have been followed.
- b) Leads have been inspected.
- c) Fuse has been checked.
- d) Battery has been checked.
- e) The unit is returned with all accessory leads.

Remember, the more information written about the fault, the quicker it will be serviced.

DISTRIBUTOR

Kyoritsu reserves the rights to change specifications or designs described in this manual without notice and without obligations.



**KYORITSU ELECTRICAL
INSTRUMENTS
WORKS, LTD.**

No.5-20,Nakane 2-chome, Meguro-ku, Tokyo
152-0031 Japan
Phone :(03) 3723-0131 Fax : (03) 3723-0152
URL : <http://www.kew-ltd.co.jp>
E-mail : info@kew-ltd.co.jp
Factories : Uwajima & Ehime