

# USER'S MANUAL

## BM878, BM877 & BM876

### Insulation Tester Combination Multimeter



## 1) SAFETY

This manual contains information and warnings that must be followed for operating the instrument safely and maintaining the instrument in a safe operating condition. If the instrument is used in a manner not specified by the manufacturer, the protection provided by the instrument may be impaired. The meter is intended only for indoor use.

### Terms in this manual

**WARNING** identifies conditions and actions that could result in serious injury or even death to the user.

**CAUTION** identifies conditions and actions that could cause damage or malfunction in the instrument.







### Information about Measurement Categories

**Measurement Category IV** is applicable to test and measuring circuits connected at the source of the building's low-voltage MAINS installation. Examples are measurements on devices installed before the main fuse or circuit breaker in the building installation.

**Measurement Category III** is applicable to test and measuring circuits connected to the distribution part of the building's low-voltage MAINS installation. Examples are measurements on distribution boards (including secondary meters), circuit-breakers, wiring, including cables, bus-bars, junction boxes, switches, socket-outlets in the fixed installation, and equipment for industrial use and some other equipment such as stationary motors with permanent connection to the fixed installation.

**Measurement Category II** is applicable to test and measuring circuits connected directly to utilization points (socket outlets and similar points) of the low-voltage MAINS installation. Examples are measurements on MAINS CIRCUITS of household appliances, portable tools and similar equipment.

### International Electrical Symbols

	Caution ! Refer to the explanation in this Manual
	Caution ! Risk of electric shock
	Earth (Ground)
	Double Insulation or Reinforced insulation
	Fuse
	AC--Alternating Current
	DC--Direct Current

The instrument is protected throughout by Double Insulation per IEC/UL/EN61010-1 Ed. 3.0, IEC/EN61010-2-030 Ed. 1.0, IEC/EN61010-2-033 Ed. 1.0, IEC/UL/EN61010-031 Ed. 1.1 and CAN/CSA-C22.2 No. 61010-1-12 Ed. 3.0 to Measurement CAT-III 1kV and CAT-IV 600V, AC & DC. All input terminals are also rated to such Measurement Categories requirements.

The instrument also meets the relevant Parts of EN61557 for CE requirements, and are not certified by UL.. In particular, Part 1 Ed. 2.0 General requirements, Part 2 Ed. 2.0 Insulation Resistance and Part 4 Ed. 2.0 Resistance of earth connection and equipotential bonding, where applicable.

## **WARNING**

To reduce the risk of fire or electric shock, do not expose this product to rain or moisture. To avoid electrical shock hazard, observe the proper safety precautions when working with voltages above 60 VDC or 30 VAC rms. These voltage levels pose a potential shock hazard to the user. Do not touch test lead tips or the circuit being tested while power is applied to the circuit being measured. Keep your fingers behind the finger guards of the test leads during measurement. Inspect test leads, connectors, and probes for damaged insulation or exposed metal before using the instrument. If any defects are found, replace them immediately. Never attempt a voltage measurement with the test lead inserted into the **INS./mA** or  input jack that is available. Only replace the blown fuse with the proper rating as specified in this manual. Only use the Test Probe Assemblies provided with the equipment or UL Listed Probe Assemblies with same rating or better. IEC 61010-031 requires exposed conductive test probe tips to be  $\leq 4\text{mm}$  for CAT III & CAT IV ratings. It is commonly achieved by permanently over-molded plastic shrouds, or by detachable Cap shrouds for interchangeable between CAT II ratings. Refer to the category markings on your probe assemblies as well as on the add-on accessories (like Caps or Clips), if any, for applicable rating changes.

## **CAUTION**

Disconnect the test leads from the test points before changing functions. Always set the instrument to the highest range and work downward for an unknown value when using manual ranging mode.

## **2) CENELEC DIRECTIVES**

The instruments conform to CENELEC Low-voltage directive 2006/95/EC and Electromagnetic compatibility directive 2004/108/EC

### 3) PRODUCT DESCRIPTION

Note: Top of the line model is used as representative for illustration purposes. Please refer to your particular model for function availability.

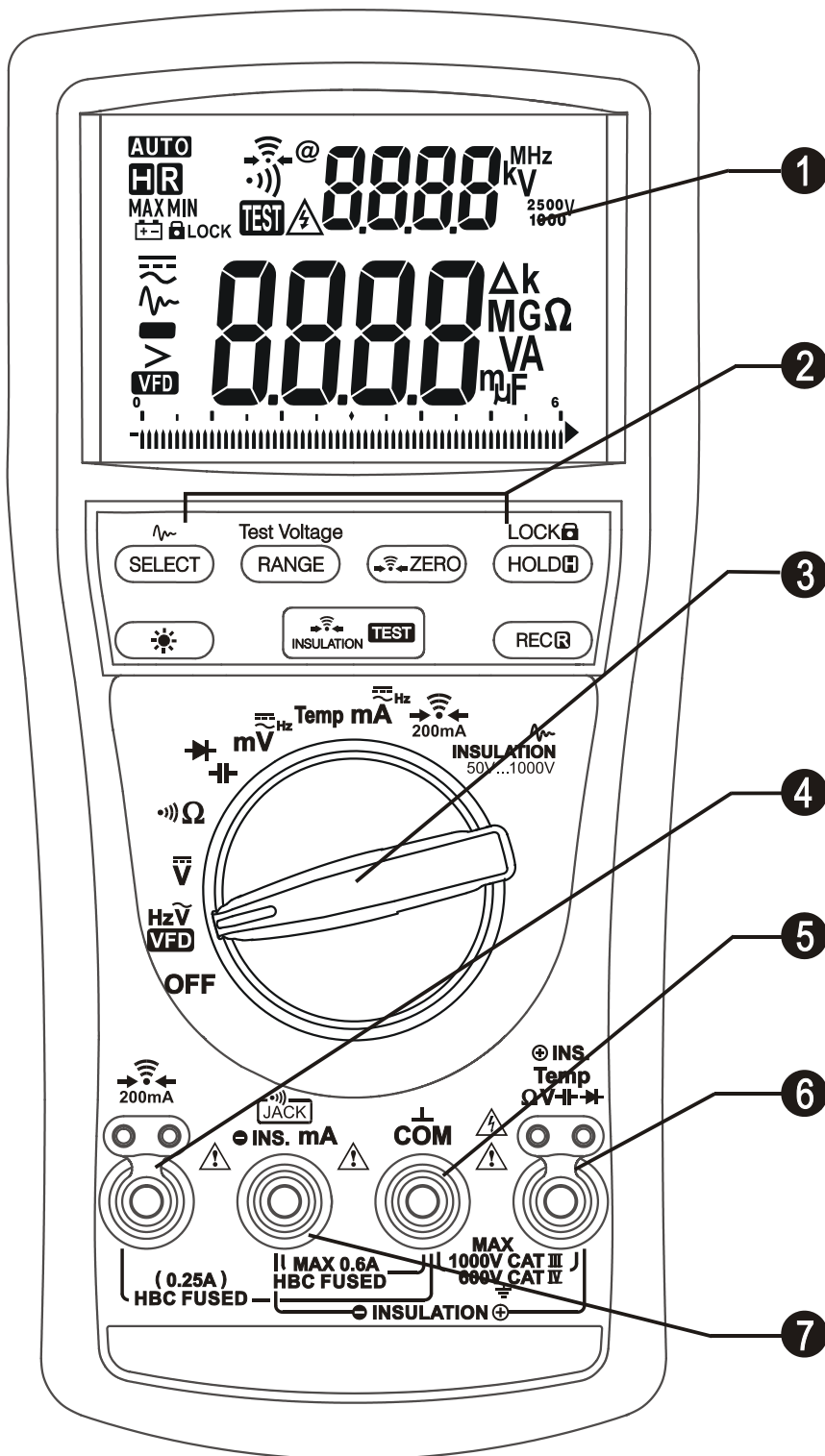

1) 3-5/6 digits 6000 counts dual displays

2) Push-buttons for special functions & features

3) Selector to turn the Power On or Off and Select a function

4) Input Jack for  Earth Continuity Test function

5) Common (Ground reference) Input Jack for all functions *EXCEPT* Insulation Resistance function

6) Input Jack for all functions *EXCEPT*  Earth Continuity Test and mA functions

7) Input Jack for Insulation function Ground reference **⊖ INS.** or mA function positive input

### Analog bar-graph

The analog bar graph provides a visual indication of measurement like a traditional analog meter needle. It is excellent in detecting faulty contacts, identifying potentiometer clicks, and indicating signal spikes during adjustments.



## 4) OPERATION

### CAUTION

Before and after hazardous voltage measurements, test the voltage function on a known source such as line voltage to determine proper meter functioning.

### ACV<sup>+Hz</sup> & VFD ACV<sup>+Hz</sup> functions

Press the **SELECT** button momentarily to toggle the subject functions. Last selection will be saved as power up default for repeat measurement convenience. For **ACV<sup>+Hz</sup>** function, press the **RANGE** button momentarily to select other ranges when needed. For **VFD ACV<sup>+Hz</sup>** function, only 600V range is available to best cope with the range of most Variable Frequency Drives (VFD) measurements.

To select **DCV** function, turn the Rotary Knob to **DCV** position for measurements.

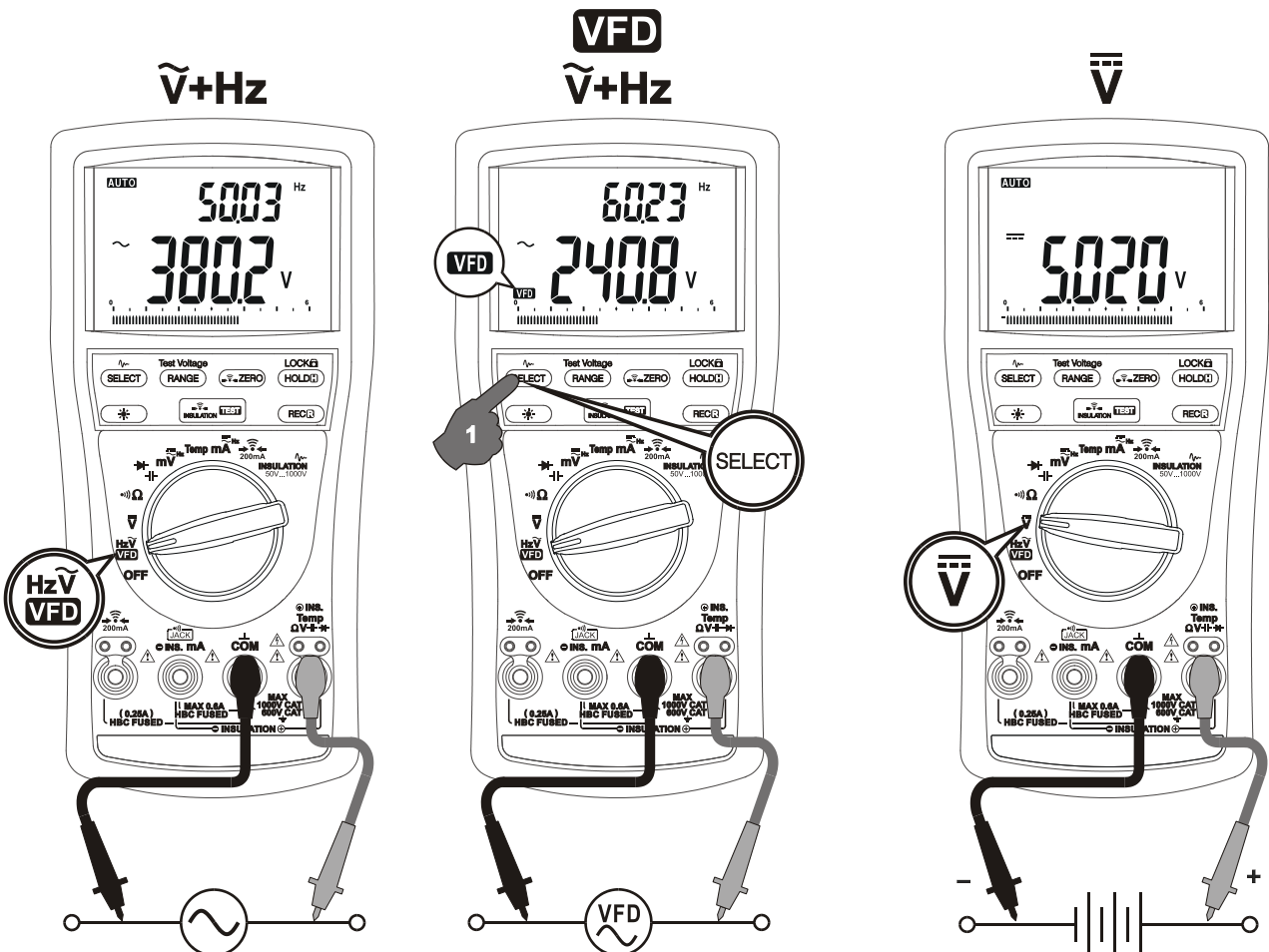

## $\Omega$ Resistance, $\cdot\cdot\cdot\cdot\cdot$ Continuity functions

Press the **SELECT** button momentarily to toggle the functions. Last selection will be saved as power up default for repeat measurement convenience.  $\cdot\cdot\cdot\cdot\cdot$  Continuity function is convenient for checking wiring connections and operation of switches. A continuous beep tone indicates a complete wire.



## CAUTION

Using resistance or continuity function in a live circuit will produce false results and may damage the instrument. In many cases the suspected component must be disconnected from the circuit to obtain an accurate reading

## ➔ Diode Test, ⇄ Capacitance (Model 878 only) functions

Press the **SELECT** button momentarily to toggle the functions. Last selection will be saved as power up default for repeat measurement convenience. (Model 877 ➔ Diode Test function is combined to its  $\Omega/\cdot\cdot\cdot/\cdot\cdot\cdot$  Rotary Knob position)

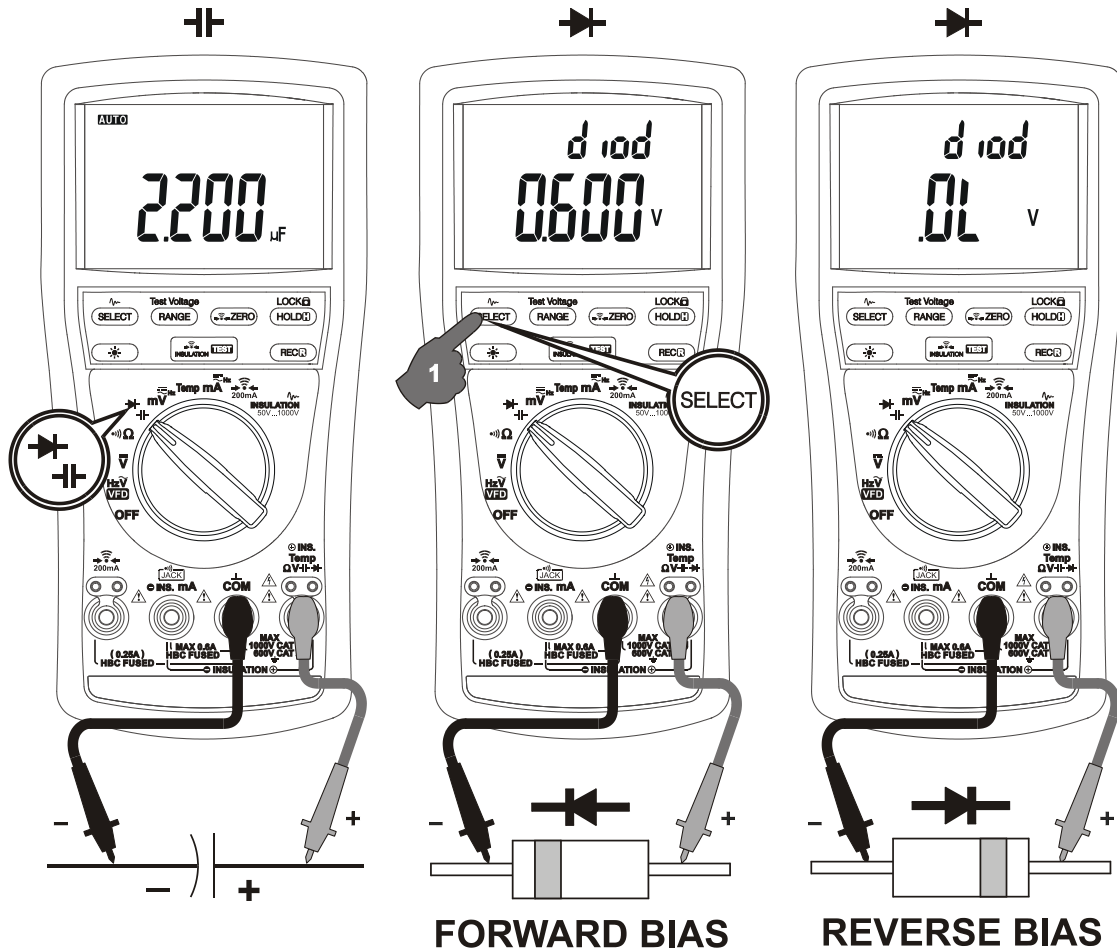

## CAUTION

Discharge capacitors before making any measurement. Large value capacitors should be discharged through an appropriate resistance load.

Normal forward voltage drop (forward biased) for a good silicon diode is between 0.400V to 0.900V. A reading higher than that indicates a leaky diode (defective). A zero reading indicates a shorted diode (defective). An OL indicates an open diode (defective). Reverse the test leads connections (reverse biased) across the diode. The digital display shows OL if the diode is good. Any other readings indicate the diode is resistive or shorted (defective).

## DCmV, ACmV <sup>+Hz</sup> functions (Model 878 only)

Press the **SELECT** button momentarily to toggle the subject functions. Last selection will be saved as power up default for repeat measurement convenience.



## Temperature functions (Model 878 only)

Press **SELECT** button momentarily to toggle °C and °F readings. Last selection will be saved as power up default for repeat measurement convenience.

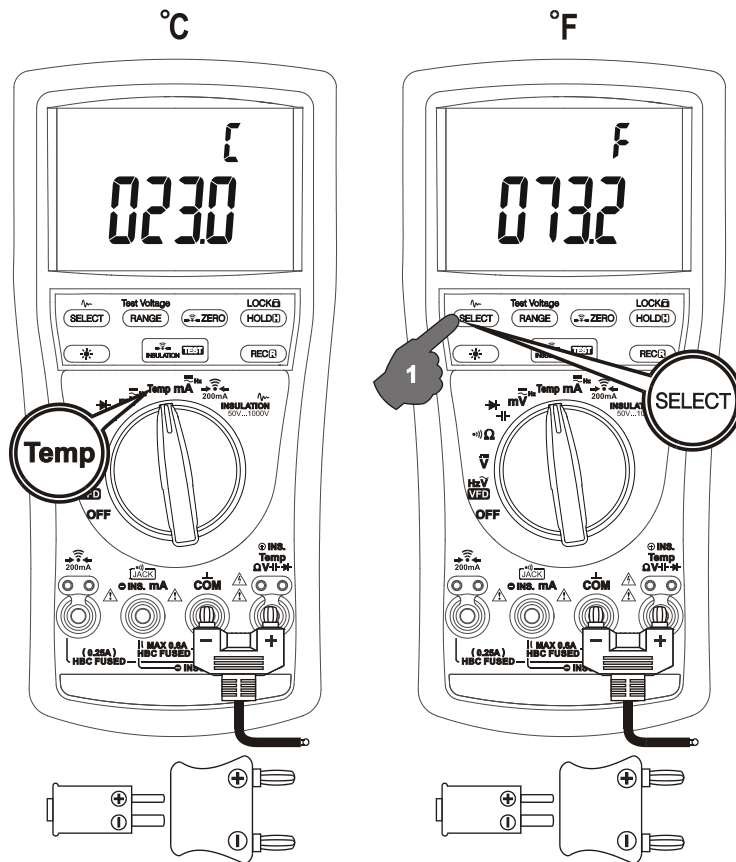

Note: Be sure to insert the banana plug type-K temperature bead probe Bkp60 with correct **+** **-** polarities. You can also use a plug adapter Bkb32 (Optional purchase) with banana pins to type-K socket to adapt other standard type-K mini plug temperature probes.

## DCmA, ACmA<sup>+Hz</sup> functions (Model 878 only)

Press the **SELECT** button momentarily to toggle the subject functions. Last selection will be saved as power up default for repeat measurement convenience.

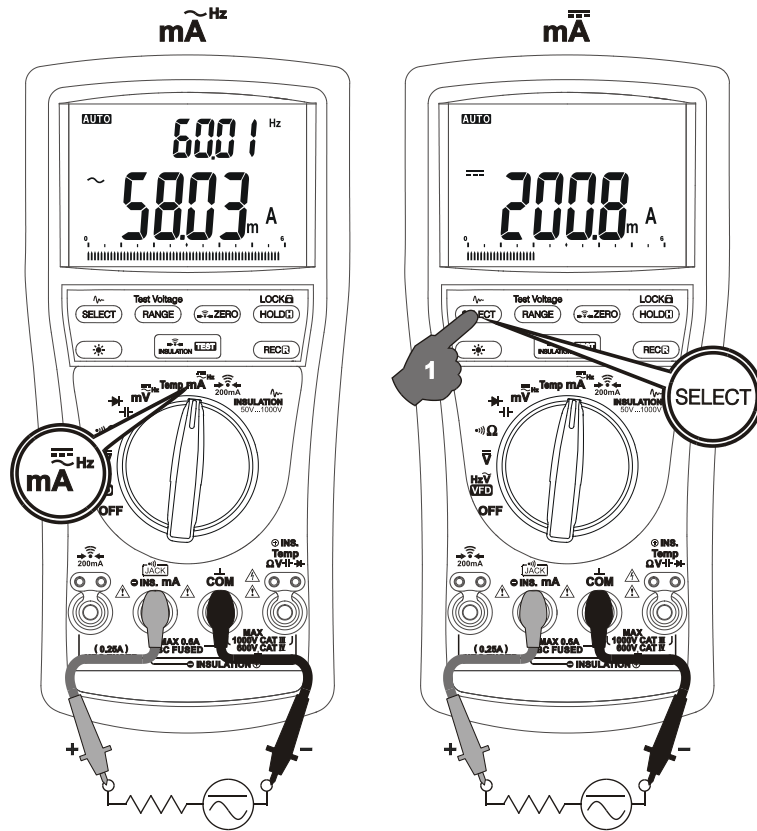

## Earth Continuity Test function (Models 878 & 877 only)

### WARNING

This function measures the Resistance values of earth connection and equipotential bonding in Low Voltage Distribution Systems up to Nominal Voltage ( $U_n$ ) 830V, phase-to-phase. DO NOT use on Systems with Nominal Voltages above that. Measurements shall only be carried out on de-energized circuits. The measuring loop is protected by an HBC 1kV F fuse against accidental extraneous overvoltages.

The LCD icon **TEST** used alone throughout in this manual is referred as active measurements of Earth Continuity Test function through the activation of the **TEST** button on the meter or on the Remote Probe. Check the fuse before each **TEST**. If the fuse is open, the meter will display “**OPEn**” when the **TEST** is being activated at no circuit connection to the probes. Refer to the maintenance section for fuse replacement.

**TEST** is inhibited when the meter beeps and displays “>2V” plus ⚡ warning against energized circuit of more than 2V is being connected, before the **TEST** is active. Connecting to energized circuits when the **TEST** is active will produce false results and may blow the protection fuse and/or damage the instrument. Always check with voltage functions and remove power from the circuits before carrying out the **TEST**.

The results of measurements can be adversely affected by impedances of additional operating circuits connected in parallel or by transient currents.

**Setup** as illustrated below. This function uses measuring currents of 200mA for 2.199Ω

range and 90mA for 21.99Ω range measurements, auto-ranging. Press the **RANGE** button momentarily to override auto-ranging and select a range. Press and hold for 1 second or more to resume auto-ranging.

The **TEST** is active as long as the **TEST** button is pressed and hold. The **TEST** buttons on the meter and on the Remote Probe work alike. The Continuity Resistance readings are shown on the primary display. The RANGE of measuring current is indicated on the secondary display as “200mA” or “90mA”. The meter further gives a beep sound for continuity when the active Resistance reading is “<2Ω”.

Default startup primary display reading is “-.-.-”. Allow enough **TEST** time for a good measuring result. After the **TEST** is released, the last measuring display stays until the next **TEST** or a function change.

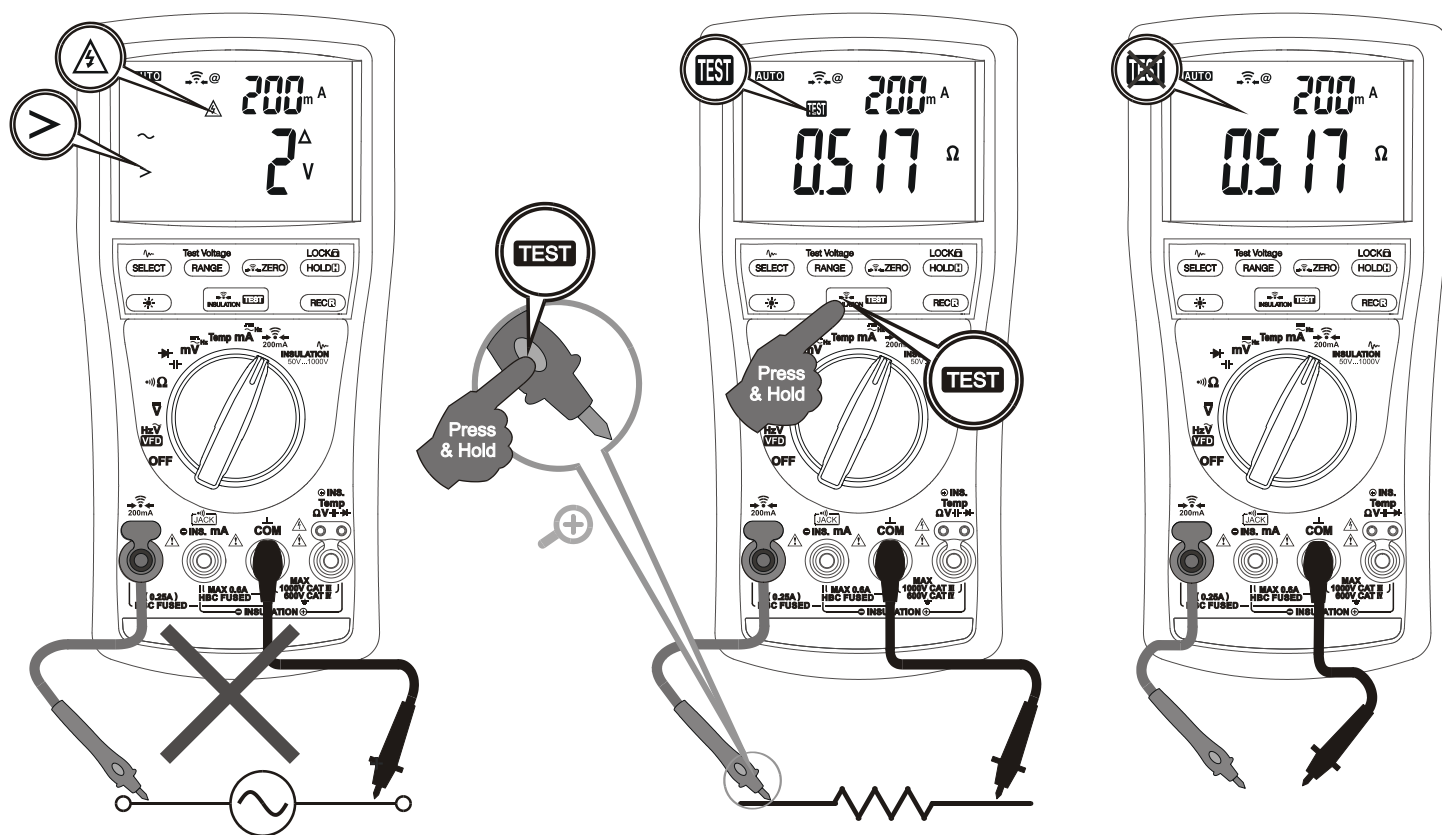

**Lock-Test mode** is recommended for continuous measurements. To apply, press the **LOCK** button momentarily to display the annunciator **LOCK** before pressing the **TEST** button momentarily. The LCD will show both **LOCK** & **TEST** to indicate continuous measurement is active. Press again either button momentarily to release the Lock-Test mode.



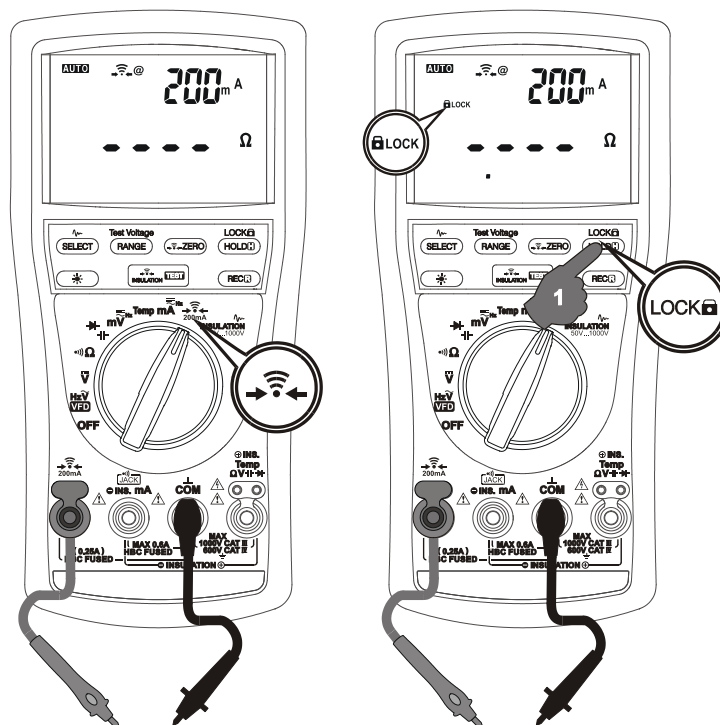

**ZERO mode** is useful for offsetting measuring probes residue resistance reading in consecutive **TEST** readings. Only residue readings from the 2.199Ω (200mA) range can be set as offset reference value. To apply, activate the Lock-Test as mentioned above. Connect the probes together to show the residue resistance reading and then press the **ZERO** button momentarily. The LCD will display a zero reading with the annunciator  $\Delta$  turns on. The residue resistance reading is then saved temporarily as offset value for the **TEST** that follows until a further function change or power off.

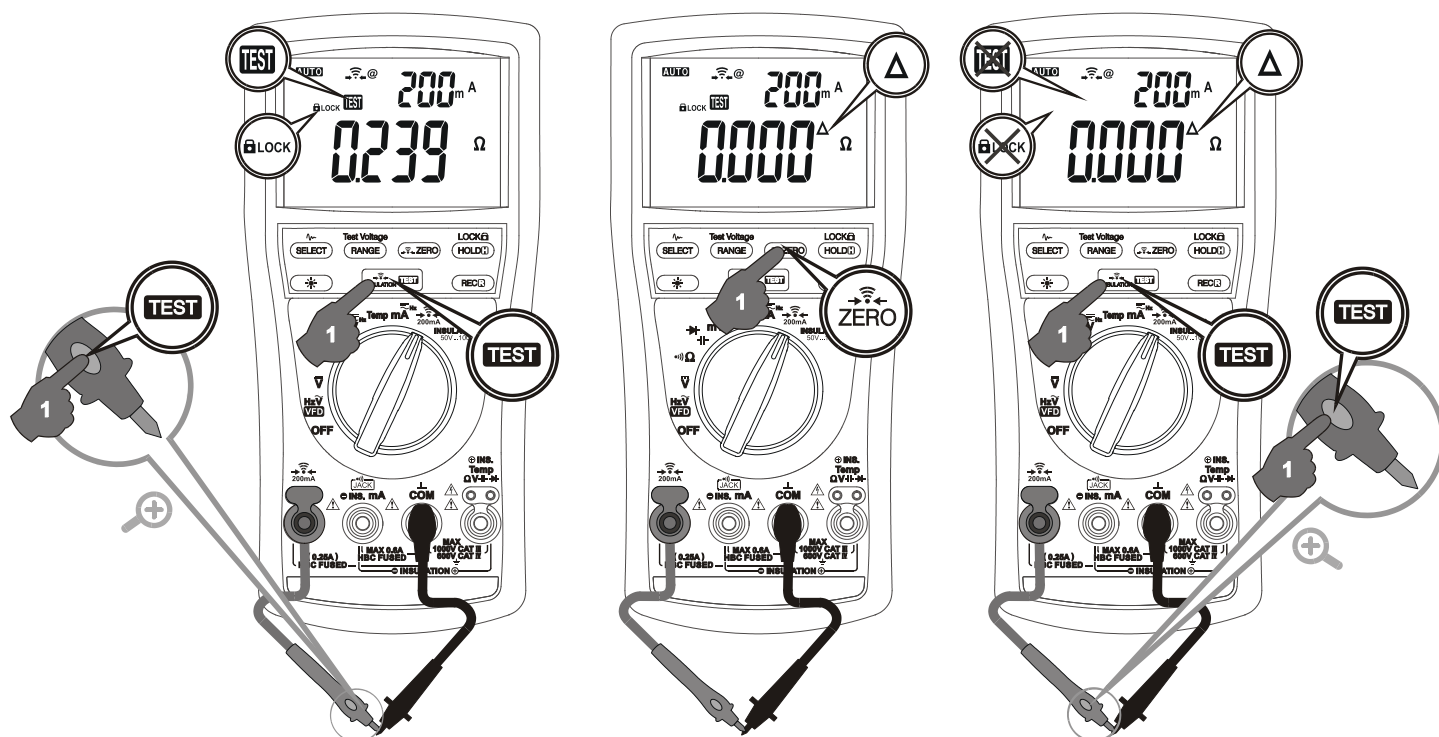

## Insulation Resistance function

### WARNING

The LCD icons **TEST** ⚡ used together throughout in this manual is referred as active measurements of Insulation Resistance function through the activation of the **TEST** button on the meter or on the Remote Probe. The **TEST** ⚡ sources a user selectable test voltage of 50V, 100V, 250V, 500V or 1000V to measure Insulation Resistance values. The ⚡ in a flashing manner warns against test voltage is being output. Use extreme caution when operating the **TEST** ⚡ to avoid electric shock.

**TEST** ⚡ is inhibited when the meter sounds 3-beeps and displays the detected voltage value plus ⚡ warning against energized circuit of more than 30V is being connected, before the **TEST** ⚡ is active. **Measurements shall only be carried out on parts of an installation or equipment that are de-energized.**

Connecting to energized circuits when the **TEST** ⚡ is active will produce false results and may damage the instrument. Always check with voltage functions and remove power from the circuits before carrying out the **TEST** ⚡.

**Setup** as illustrated below.

Select an intended test voltage of 50V, 100V, 250V, 500V or 1000V. For model 878, press the **RANGE** (Test Voltage) button momentarily to select the voltage in sequence. Last selection will be saved as power up default for repeat measurement convenience. For Models 877 or 876, turn the Rotary Knob directly to select the intended voltage instead.

The secondary display shows the selected voltage for 1 second right after the selection, and then displays the actual detected voltage readings. The voltage annunciator by the secondary display remains indicating the voltage selected.

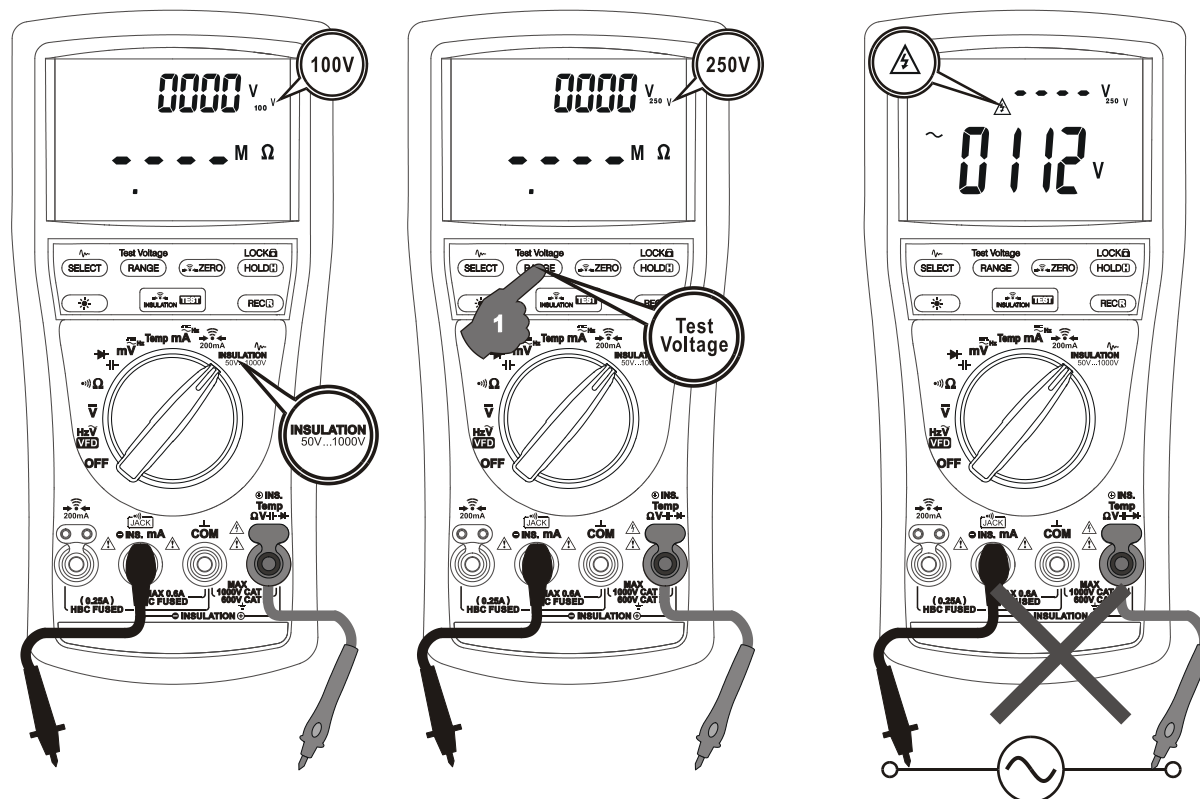

The **TEST** ⚡ is active as long as the **TEST** button is pressed and hold. The **TEST** buttons on the meter and on the Remote Probe work alike. The Insulation Resistance readings are shown on the primary display.



Default startup primary display reading is “-.---”. Allow enough **TEST** ⚡ time for a good measuring result. After the **TEST** ⚡ is released, the measuring loop starts to discharge the testing voltage. The last measured resistance reading stays on the primary display until the next **TEST** ⚡ or a function change. The secondary display keeps showing the actual detected voltage readings.

**Lock-Test mode** is recommended for continuous measurements. To apply, press the **LOCK** button momentarily to display the annunciator **LOCK** before pressing the **TEST** button momentarily. The LCD will show both **LOCK** & **TEST** ⚡ to indicate continuous measurement is active. Press again either button momentarily to release the Lock-Test mode.

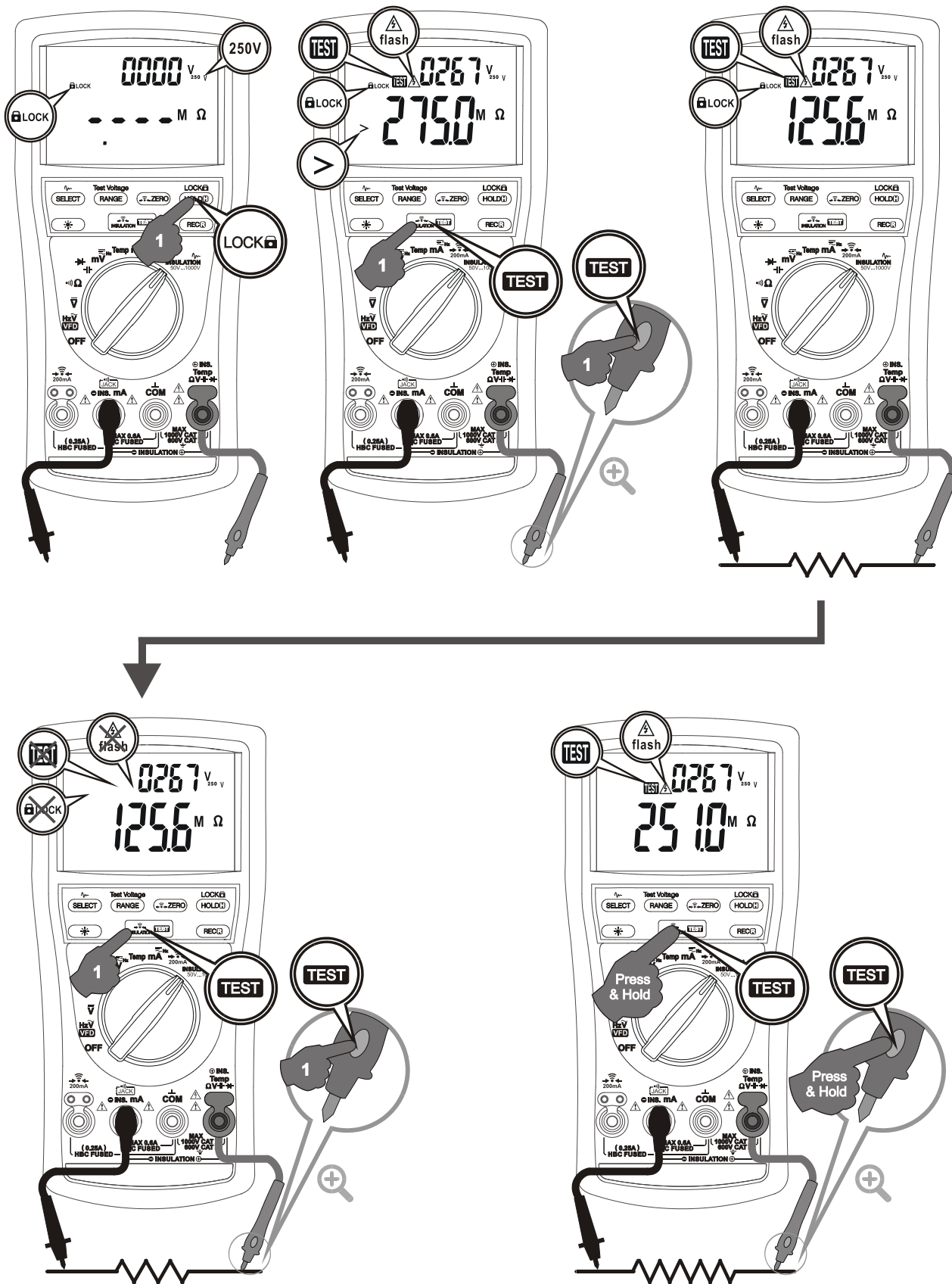
NOTE. Maximum display reading of each Insulation Resistance range is subjected to the test voltage selected. They are 55.0MΩ, 110.0MΩ, 275MΩ, 550MΩ & 25.0GΩ for 50V, 100V, 250V, 500V & 1000V respectively. Over-range is indicated as > maximum-display-reading.



## COMPARE mode (Models 877 & 876 only)

This mode uses a preset insulation resistance threshold value for PASS/FAIL measuring comparison. The LCD annunciator **PASS** turns on when the **TEST**  reading is higher than the selected threshold value. On the contrary, the LCD annunciator **FAIL** turns on and the meter chirps when the **TEST**  reading is below such value.

To enable, press the **COMPARE** button momentarily. The LCD annunciator **C** turns on. Press the **COMPARE** button momentarily again to select the preset threshold values in sequence. Last threshold values selected for each test voltage range will be saved separately as power up default for repeat measurement convenience. Press the **COMPARE** button for 1 second or more to exit.

NOTE. Selectable threshold values for the test voltage ranges are 100kΩ/ 200kΩ/ 500kΩ/ 1MΩ/ 2MΩ/ 5MΩ/ 10MΩ/ 20MΩ/ 50MΩ for 50V & up. Additional 100MΩ for 100V & up, 200MΩ for 250V & up and 500MΩ for 500V & 1000V ranges.

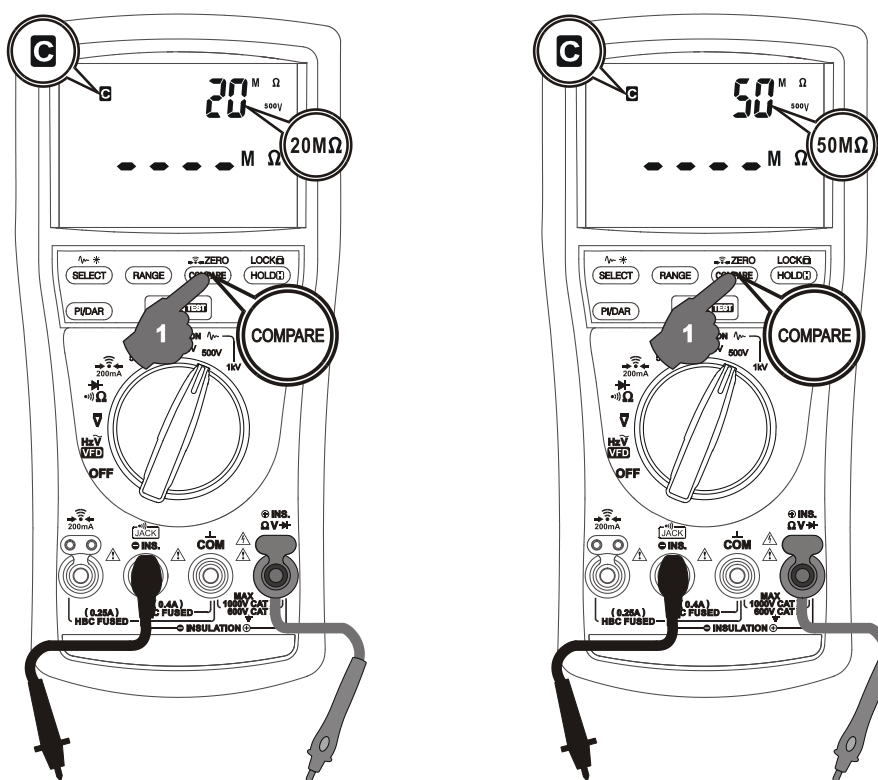

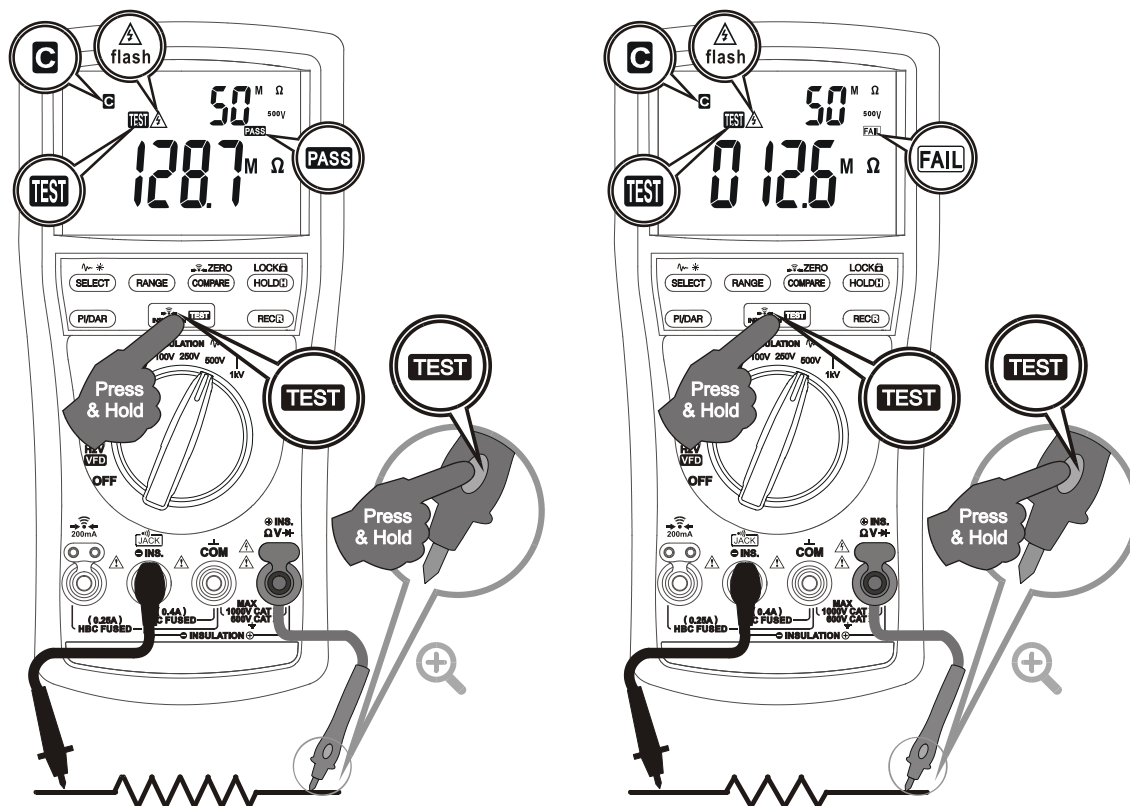

### PI/DAR mode (Models 877 & 876 only)

**PI** (Polarization Index) is the ratio of the 10-minute insulation resistance to the 1-minute insulation resistance.

$$PI = \frac{R_{(10\text{-min})}}{R_{(1\text{-min})}}$$

**DAR** (Dielectric Absorption Ratios) is the ratio of the 1-minute insulation resistance to the 30-second insulation resistance.

$$DAR = \frac{R_{(1\text{-min})}}{R_{(30\text{-sec})}}$$

A general guide to interpret the PI or DAR test results are:

Insulation Condition	PI (Polarization Index)	DAR (Dielectric Absorption Ratios)
Dangerous	<1.0	-
Questionable	<2.0	<1.3
Good	<4.0	<1.6
Excellent	>4.0	>1.6

Press the **PI/DAR** button momentarily to enable PI mode with the LCD annunciator **PI** turned on. Press momentarily again toggles to the DAR mode with the LCD annunciator **DAR** turned on. The secondary display shows the measuring lap times of **10'00"** and **01'00"** for PI and DAR modes respectively.





Then, activate Lock-Test mode **LOCK & TEST** to start PI or DAR count-down measurements. The timer on the secondary display started to count down. The primary display shows the real-time resistance readings until the timer shows **00'00"** for a result. The maximum display result is **"5.0"**, and the display shows **">5.0"** for results beyond that. If the measured resistance reading is over-range, the meter will stop **TEST** and display **"Err"**. Press the **PI/DAR** button for 1 second or more to exit.





### Smooth mode (Insulation Resistance function only)

Smooth  mode displays the running average of the last eight measured readings having changes within 300 counts in sequence. On the contrary, it displays directly, without smoothing, the measured reading that is beyond 300 counts in changes comparing to its former one. Press the  button momentarily to enable with LCD annunciator " turned on. Press momentarily again to disable.

### Backlight display

For Model 878, press the  button momentarily to toggle the LCD backlight. For Models 877 & 876, press **SELECT** button for a second or more to toggle the LCD backlight. The backlight will also be turned off automatically after approximate 37 seconds to extend battery life.

### Auto- or Manual-ranging (Volts, mA & $\Omega$ functions only)

Press the **RANGE** button momentarily to select manual-ranging, and the meter will remain in the range it was in, the LCD **AUTO** turns off. Press the button momentarily again to select an adjacent range. Press and hold the button for 1 second or more to resume auto-ranging.

### Hold

The hold feature freezes the display for later view. Press the **HOLD** button momentarily to toggle the hold feature. This feature does not apply to Earth Continuity Test & Insulation Resistance functions.

### MAX/MIN Recording mode

Press **REC** button momentarily to activate MAX/MIN recording mode. The LCD "**R**" & "**MAX MIN**" turn on. The meter beeps when a new MAX (maximum) or MIN (minimum) reading is updated. Press the button momentarily to read the Real-time, MAX and MIN readings in sequence. Press the button for 1 second or more to exit MAX/MIN recording mode. When activated, Auto-Power-Off is disabled automatically. This feature does not apply to Earth Continuity Test & Insulation Resistance functions.

### Beep-Jack™ Input Warning

The meter beeps as well as displays "**InEr**" to warn the user against possible damage to the meter due to improper connections to the "**mA**" ("**INS. mA**" for Model 878) input jack when other functions, especially voltage function, is selected.

## Set Beeper Off

Press the **RANGE** button while turning the meter on to temporarily disable the Beeper feature. Turn the rotary switch OFF and then back on to resume.

## Auto-Power-off (APO)

The Auto-Power-off (APO) mode turns the meter off automatically to extend battery life after approximately 20 minutes of no rotary switch or push button operations. To wake up the meter from APO, press the **SELECT**, **⚡** or **PI/DAR** button momentarily or turn the rotary switch OFF and then back on. Always turn the rotary switch to the OFF position when the meter is not in use.

## Disabling Auto-Power-off

Press the **SELECT** button while turning the meter on to temporarily disable the Auto-Power-Off feature. Turn the rotary switch OFF and then back on to resume.

## 5) MAINTENANCE

### WARNING

To avoid electrical shock, disconnect the meter from any circuit, remove the test leads from the input jacks and turn OFF the meter before opening the case. Do not operate with open case. Install only the same type of fuse or equivalent

### Calibration

Accuracy is specified for a period of one year after calibration. Periodic calibration at intervals of one year is recommended to maintain meter accuracy.

### Cleaning and Storage

Periodically wipe the case with a damp cloth and mild detergent; do not use abrasives or solvents. If the meter is not to be used for periods of longer than 60 days, remove the battery and store it separately

### Trouble Shooting

If the instrument fails to operate, check battery, fuses, leads, etc., and replace as necessary. Double check operating procedure as described in this user's manual

If the instrument voltage-resistance input terminal has subjected to high voltage transient (caused by lightning or switching surge to the system) by accident or abnormal conditions of operation, the series input protection resistors may be blown off (become

high impedance) like fuses to protect the user and the instrument. Most measuring functions through this terminal will then be open circuit. The series input protection resistors and the spark-gaps (or varistors) should then be replaced by qualified technician. Refer to the LIMITED WARRANTY section for obtaining warranty or repairing service.

## Battery and Fuse replacement

**Battery use:** Four 1.5V AA battery (IEC LR6)

**Fuses use:**

Fuse (F2) for **INS/mA** input:

0.4A/1000Vac & Vdc, IR 30kA or better, FF fuse; Dimension: 6 x 32 mm

Fuse (F3) for Earth Continuity Test input:

0.25A/1000Vac & Vdc, IR 30kA or better, FF fuse; Dimension: 6 x 32 mm

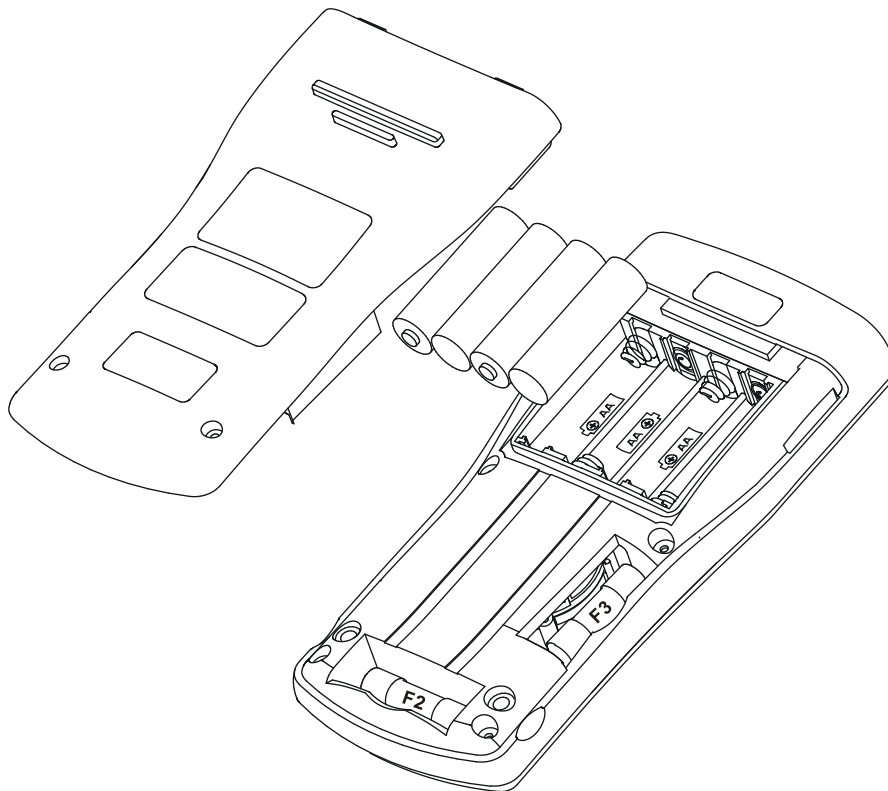

## Battery and Fuse replacement:

Loosen the screws from the access cover of the case bottom. Lift the access cover. Replace the batteries or fuse. Re-fasten the screws.

## GENERAL SPECIFICATION

**Display:** 3-5/6 digits 6,000 counts

**Polarity:** Automatic

**Update Rate:** 5 per second nominal

**61 Segments Bar graph:** 40 per second max

**Operating Temperature:** -10°C to 40°C

**Relative Humidity:** Maximum relative humidity 90% for temperature up to 28°C decreasing linearly to 50% relative humidity at 40°C

**Pollution Degree:** 2

**IP Rating:** IP40

**Storage Temperature:** -20°C to 60°C, < 80% R.H. (with battery removed)

**Altitude:** Operating below 2000m

**Temperature Coefficient:** nominal 0.15 x (specified accuracy)/ °C @(-10°C ~ 18°C or 28°C ~ 40°C), or otherwise specified

**Sensing:** AC, True RMS

**Safety:** Double insulation per IEC/UL/EN61010-1 Ed. 3.0, IEC/EN61010-2-030 Ed. 1.0, IEC/EN61010-2-033 Ed. 1.0, IEC/UL/EN61010-031 Ed. 1.1 and CAN/CSA-C22.2 No. 61010-1-12 Ed. 3.0 to Category III 1000 V AC & DC and Category IV 600V AC & DC

**Compliance to IEC/EN61557:2007** (Per CE requirements, not certified by UL): IEC/EN61557-1, IEC/EN61557-2 & IEC/EN61557-4 where applicable

### Overload Protections:

Insulation Resistance & mA (Model 878 only): 0.4A/1KV, IR 30kA or better

Earth Continuity Test (Models 878 & 877 only): 0.25A/1KV, IR 30kA or better

V: 1100Vrms

mV, Ω & Others: 1000 Vrms

**Transient Protection:** 8kV (1.2/50µs surge)

**E.M.C.:** Meets EN61326-1:2006 (EN55022, EN61000-3-2, EN61000-3-3, EN61000-4-2, EN61000-4-3, EN61000-4-4, EN61000-4-5, EN61000-4-6, EN61000-4-8, EN61000-4-11)

In an RF field of 3V/m:

Total Accuracy = Specified Accuracy + 25 digits

Performance above 3V/m is not specified

**Power Supply:** Four Alkaline AA batteries (IEC LR6)

**Power Consumption:** 4.5mA typical except:

ACV <sup>+Hz</sup> & VFD ACV <sup>+Hz</sup>: 7.0mA

Earth Continuity Test:

110mA @20Ω Range

220mA @2.0Ω Range

Tester can perform at least 3000 Earth Continuity Test measurements with new alkaline batteries at room temperature. These are standard tests of 1 Ω with a duty cycle of 5 seconds on and 25 seconds off.

Insulation Resistance @1mA test current:

50V output voltage: 25mA

100V output voltage: 45mA

250V output voltage: 85mA

500V output voltage: 170mA

1000V output voltage: 440mA

Tester can perform at least 950 insulation tests with new alkaline batteries at room temperature. These are standard tests of 1000 V into 1 MΩ with a duty cycle of 5 seconds on and 25 seconds off.

**Low Battery:** approx. 4.6V

**APO Timing:** Idle for 20 minutes

**APO Consumption:** 50μA typical

**Dimension:** L208mm X W103mm X H64.5mm with holster

**Weight:** 635 gm with holster

**Accessories:** Test probe pair, Alligator clip pair, Remote control probe (Models 878 & 877 only), Holster, User's manual, Bkp60 banana plug K-type thermocouple (Model 878 only)

**Optional Accessories:** Remote control probe (Model 876 only), BKB32 banana plug to type-K socket plug adaptor (Model 878 only)

**Special Features:** Record MAX/MIN readings; Display Hold; Backlighted LCD; VFD V & Hz readings; Lock-Test mode for Insulation resistance & Earth Continuity Test (Models 878 & 877 only); BeepJack™ audible & visible input warning; PI/DAR mode (Models 877 & 876 only); Compare mode (Models 877 & 876 only)

## Electrical Specifications

Accuracy is  $\pm$ (% reading digits + number of digits) or otherwise specified, at 23°C  $\pm$  5°C & less than 80% relative humidity.

True RMS voltage & current accuracies are specified from 1 % to 100 % of range or otherwise specified. Maximum Crest Factor < 1.70:1 at full scale & < 3.4:1 at half scale, and with frequency components within the specified frequency bandwidth for non-sinusoidal waveforms.

**AC Voltage**

RANGE	Accuracy
50Hz ~ 60Hz	
6.000V, 60.00V, 600.0V, 1000V	1% + 3d
60Hz ~ 1kHz	
6.000V, 60.00V, 600.0V, 1000V	2% + 3d
1kHz ~ 3kHz	
6.000V, 60.00V	2% + 3d
600.0V, 1000V	Unspecified
3kHz ~ 5kHz	
6.000V, 60.00V	4% + 5d
600.0V, 1000V	Unspecified

Input impedance: 10M $\Omega$ , 110pF nominal

**VFD AC Voltage**

RANGE	Accuracy <sup>1)</sup>
10Hz ~ 45Hz	
600.0V	4% + 5d
45Hz ~ 200Hz	
600.0V	2% + 5d
200Hz ~ 440Hz	
600.0V	7% + 5d <sup>2)</sup>

<sup>1)</sup>Unspecified for fundamental frequency > 440Hz

<sup>2)</sup>Accuracy linearly decreases from 2% + 5d @200Hz to 7% + 5d @440Hz

Input impedance: 10M $\Omega$ , 110pF nominal

**DC Voltage**

RANGE	Accuracy
6.000V, 60.00V, 600.0V	0.2% + 3d
1000V	0.3% + 3d

Input impedance: 10M $\Omega$ , 110pF nominal

**Ohms**

RANGE	Accuracy
600.0Ω	0.9% + 5d
6.000kΩ, 60.00kΩ, 600.0kΩ	0.9% + 2d
6.000MΩ	1.2% + 3d
60.00MΩ	3.0% + 6d

Open Circuit Voltage: < 1.5VDC typical

**Audible Continuity Tester**

Audible threshold: between 20Ω and 200Ω

Response time < 30ms

**Diode Tester**

Range	Accuracy	Test Current (Typical)	Open Circuit Voltage
2.000V	1.5% + 4d	0.5mA	< 2.8 VDC

**Capacitance (Model 878 only)**

RANGE	Accuracy <sup>1)</sup>
3.000μF <sup>2)</sup> , 30.00μF, 300.0μF, 3000μF	1.5% + 5d
30.00mF	10% + 5d

<sup>1)</sup>Accuracies with film capacitor or better

<sup>2)</sup>Readings not available below 200nF

**DCmV (Model 878 only)**

RANGE	Accuracy
60.00mV,	0.5% + 3d
600.0mV,	0.1% + 3d

Input impedance: 10MΩ, 140pF nominal

**ACmV (Model 878 only)**

RANGE	Accuracy	
60.00mV, 600.0mV	50Hz ~ 60Hz	1% + 3d
	60Hz ~ 3kHz	2% + 3d
	3kHz ~ 5kHz	3% + 5d

Input impedance: 10MΩ, 140pF nominal



**Temperature (Model 878 only)**

RANGE	Accuracy <sup>1)</sup>
-50.0°C ~ 0.0°C	2% + 3°C
0.0°C ~ 50.0°C	2.2°C
50.0°C ~ 537.0°C	2% + 2°C
-58.0°F ~ 32.0°F	2% + 6°F
32.0°F ~ 122.0°F	4.4°F
122.0°F ~ 999.0°F	2% + 4°F

<sup>1)</sup>Type-K thermocouple range & accuracy not included

**DCmA (Model 878 only)**

RANGE	Accuracy	Burden Voltage
60.00mA, 600.0mA	0.5% + 3d	3.0mV/mA

**ACmA (Model 878 only)**

RANGE	Accuracy	Burden Voltage
	50Hz ~ 1KHz	
60.00mA, 600.0mA	1.5% + 3d	3.0mV/mA

**Earth Continuity Test (Models 878 & 877 only)**

RANGE	Test Current	Accuracy	Measuring Range <sup>1)</sup>
2.000Ω	> 200mA	1.5%+3d	0.015Ω ~ 2.199Ω
20.00Ω	> 90mA		0.15Ω ~ 21.99Ω

Open Circuit Voltage: > 4VDC

Live Circuit Detector: Inhibit test if terminal voltage > 2V prior to initialization of test.

<sup>1)</sup>Specified measuring range at percentage operating uncertainty  $B[\%] \leq \pm 30\%$  per IEC/EN61557-4 requirements

## ~ Hz Line Level Frequency

Function RANGE	Sensitivity (Sine RMS)	Range
60mV <sup>1)</sup>	6mV	10Hz ~ 50kHz
600mV <sup>1)</sup>	60mV	10Hz ~ 100kHz
6V	0.6V	10Hz ~ 20kHz
60V	6V	10Hz ~ 20kHz
600V	60V	10Hz ~ 3kHz
1000V	600V	10Hz ~ 3kHz
VFD 600V	60V ~ 240V <sup>2)</sup>	10Hz ~ 440Hz
60mA <sup>1)</sup>	6mA	10Hz ~ 5kHz
600mA <sup>1)</sup>	60mA	10Hz ~ 5kHz

Accuracy: 0.02%+4d

<sup>1)</sup>Model 878 Only

<sup>2)</sup>VFD sensitivity linearly decreases from 10% F.S. @ 200Hz to 40% F.S. @ 440Hz

## Insulation Resistance

Test Voltage <sup>1)</sup>	Range	Test Current	Accuracy
50V	3.000MΩ, 30.00MΩ, 55.0MΩ	1mA @50kΩ	1.5%+5d
100V	3.000MΩ, 30.00MΩ, 110.0MΩ	1mA @100kΩ	
250V	3.000MΩ, 30.00MΩ, 275.0MΩ	1mA @250kΩ	
500V	3.000MΩ, 30.00MΩ, 300.0MΩ, 550.0MΩ	1mA @500kΩ	
1000V	3.000MΩ, 30.00MΩ, 300.0MΩ	1mA @1MΩ	1.5%+5d
	3000MΩ		2.0%+5d
	25.0GΩ		10%+5d

<sup>1)</sup>Actual output voltage: 100% ~ 120% of Test Voltage

Live Circuit Detector: Inhibit test and display voltage reading instead if terminal voltage > 30V prior to initialization of test. Display voltage accuracies:

DCV: 1.5% + 5d

ACV: 3.0% + 5d @50Hz ~ 60Hz (for Models 877 & 876, unspecified @ > 600Vac )

Specified measuring range is 0.020MΩ ... 25.0GΩ for percentage operating uncertainty  $B[\%] \leq \pm 30\%$  per IEC/EN61557-2 requirements

## LIMITED WARRANTY

BRYMEN warrants to the original product purchaser that each product it manufactures will be free from defects in material and workmanship under normal use and service within a period of one year from the date of purchase. BRYMEN's warranty does not apply to accessories, fuses, fusible resistors, spark gaps, varistors, batteries or any product which, in BRYMEN's opinion, has been misused, altered, neglected, or damaged by accident or abnormal conditions of operation or handling.

To obtain warranty service, contact your nearest BRYMEN authorized agent or send the product, with proof of purchase and description of the difficulty, postage and insurance prepaid, to BRYMEN TECHNOLOGY CORPORATION. BRYMEN assumes no risk for damage in transit. BRYMEN will, at its option, repair or replace the defective product free of charge. However, if BRYMEN determines that the failure was caused by misused, altered, neglected, or damaged by accident or abnormal conditions of operation or handling, you will be billed for the repair.

THIS WARRANTY IS EXCLUSIVE AND IS IN LIEU OF ALL OTHER WARRANTIES, EXPRESSED OR IMPLIED, INCLUDING BUT NOT LIMITED TO ANY IMPLIED WARRANTY OR MERCHANTABILITY OR FITNESS FOR A PARTICULAR PURPOSE OR USE. BRYMEN WILL NOT BE LIABLE FOR ANY SPECIAL, INDIRECT, INCIDENTAL OR CONSEQUENTIAL DAMAGES.



**BRYMEN TECHNOLOGY CORPORATION**

**TEL:+886 2 2226 3396**

**FAX:+886 2 2225 0025**

**<http://www.brymen.com>**



PRINTED ON RECYCLABLE PAPER, PLEASE RECYCLE

COPYRIGHT © MMXIV BTC,

ALL RIGHTS RESERVED

P/N: 7M1C-1391-0000

PRINTED IN TAIWAN